

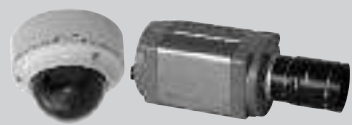

Video Systems

CONTENTS

IP CAMERAS



- IP Dome Cameras.....3
- IP Box Cameras.....4
- IP PTZ Cameras.....5

BOX CAMERAS



- Color Cameras.....10
- Day/night Cameras.....10
- Wide Dynamic Range Cameras.....10
- Wide Dynamic + Day/Night Cameras.....11
- Wide Dynamic + True Day/Night Cameras.....12

DOME CAMERAS



- Indoor Mini Dome Cameras.....14
- Outdoor / Indoor Mini Dome Cameras.....15

PTZ CAMERAS



- ACUIX Series.....19
- ACUIX ES Series.....25
- Performance HDT Series.....27
- Vista Series.....28
- Scan Dome III Series.....29

HOUSING, MOUNTS & LENSES



- Housing & Mounts**
- Indoor Mini-Domes.....31
 - Indoor/Outdoor Mini-Domes.....31
 - Box Camera Accessories.....32
 - Box Camera Indoor.....33
 - Box Camera Indoor/Outdoor.....33
 - Box Camera Outdoor.....34
 - ACUIX & ACUIX ES.....35
- Lenses**
- Manual Iris.....36
 - Auto Iris.....37
 - IR Corrected.....38
 - Zoom.....38

IR CAMERAS



- IR Bullet Cameras.....40
- IR Dome Cameras.....41

SPECIAL PURPOSE CAMERAS



- Explosion Proof PTZ Camera System.....44
- Explosion Proof Fixed Camera System.....44
- Parascan Cameras and Modules.....45

RECORDING SOLUTIONS



- PC Based Recorders.....47
- Embedded Recorders.....55

MANAGEMENT SOFTWARE & SYSTEMS



- MaxPro VMS.....61
- IP Encoder.....63
- Matrix Switching Systems.....64
- Intelligent Video and Data Analytics.....66

SYSTEM COMPONENTS



- Keyboards and Controllers.....69
- LCD Monitors.....71
- Surge Protectors.....72
- Power Supplies.....73

IP Cameras

Box Cameras

Dome Cameras

PTZ Cameras

IR Cameras

Housing, Mounts & Lenses

Special Purpose Cameras

Recording Solutions

Management Software & Systems

System Components



IP CAMERAS

Honeywell's IP digital cameras provide high resolution protection for any business that is infinitely expandable over an existing network. IP options are available in specific megapixel, PTZ, box and fixed mini-dome cameras.

The HCX Megapixel Series and EQUIP™ Series in IP camera range are supported by a web browser and a variety of video management systems, including Honeywell's MAXPRO™ VMS, a top level solution that capitalizes on an end user's existing video surveillance investment.

ACUIX™ IP: The perfect PTZ choice for customers who are seeking to control costs by capitalizing on existing IT infrastructure. Because it supports analog communication, ACUIX IP enables customers with a traditional analog system to future proof their system and maximize their PTZ investment.

THIS SECTION INCLUDES:

- IP Dome Cameras
- IP Box Cameras
- IP PTZ Cameras

IP Cameras | DOME

IP Cameras

Box Cameras

Dome Cameras

PTZ Cameras

IR Cameras

Housing, Mounts & Lenses

Special Purpose Cameras

Recording Solutions

Management Software & Systems

System Components

IP DOME CAMERAS

“Open your world to the power of IP”.

Our HD cameras provide high definition picture quality at an efficient bandwidth, resulting in storage savings

Indoor



HD3MDIP (NTSC) | HD3MDIPX (PAL)
1/4" CMOS, EQUIP® Series, 720p Resolution Camera, Network True Day/Night, 24 VAC, 3.3-12 mm VFAI

NEW!



HD3MDIH (NTSC) | HD3MDIHX (PAL)
1/4" CMOS, 720p Resolution Camera, H.264, Network True Day/Night, 24 VAC, 3.3-12 mm VFAI

H.264

Indoor-Outdoor



HD4MDIP (NTSC) | HD3MDIPX (PAL)
1/4" CMOS, EQUIP® Series, 720p Resolution Camera, Network, True Day/Night Rugged, 24 VAC, 3.3-12 mm VFAI,

NEW!



HD4MDIH (NTSC) | HD4MDIHX (PAL)
1/4" CMOS, 720p Resolution Camera, H.264, Network True Day/Night, Rugged, 24 VAC, 3.3-12 mm VFAI

H.264

IP Cameras | BOX

IP BOX CAMERAS

“Open your world to the power of IP”.

Our HD cameras provide high definition picture quality at an efficient bandwidth, resulting in storage savings

Megapixel



HCX5DW2 (NTSC + PAL)

1/2" CMOS 5 Megapixel Color Network Camera, 12 VDC/24 VAC, 4.5 mm to 13 mm VFMI



HCX3W (NTSC + PAL)

1/2" CMOS 3.1 Megapixel Color Network Camera, 12 VDC/24 VAC, 4.0 mm to 10 mm VFMI



HCX13MW (NTSC + PAL)

1/3" CMOS 1.3 MegaPixel Color Network Camera, 12 VDC/24 VAC, 4.0 mm to 10 mm VFMI

True Day & Night



HCD554IP (NTSC) | HCD554IPX (PAL)

IP, True Day/ Night, Super high resolution, EQUIP series, 12VDC/ 24VAC

NEW!



HCD5MIH (NTSC) | HCD5MIHX (PAL)

EQUIP Series 1/4" Progressive Scan, CMOS, 720p Resolution True Day/Night Camera, 24 VAC or PoE, IEEE 802.3 af, PAL

IP Cameras

Box Cameras

Dome Cameras

PTZ Cameras

IR Cameras

Housing, Mounts & Lenses

Special Purpose Cameras

Recording Solutions

Management Software & Systems

System Components

IP Cameras

ACUIX IP PTZ

IP Cameras

ACUIX IP PTZ Cameras

ACUIX IP PTZ CAMERAS

In-Ceiling PTZ

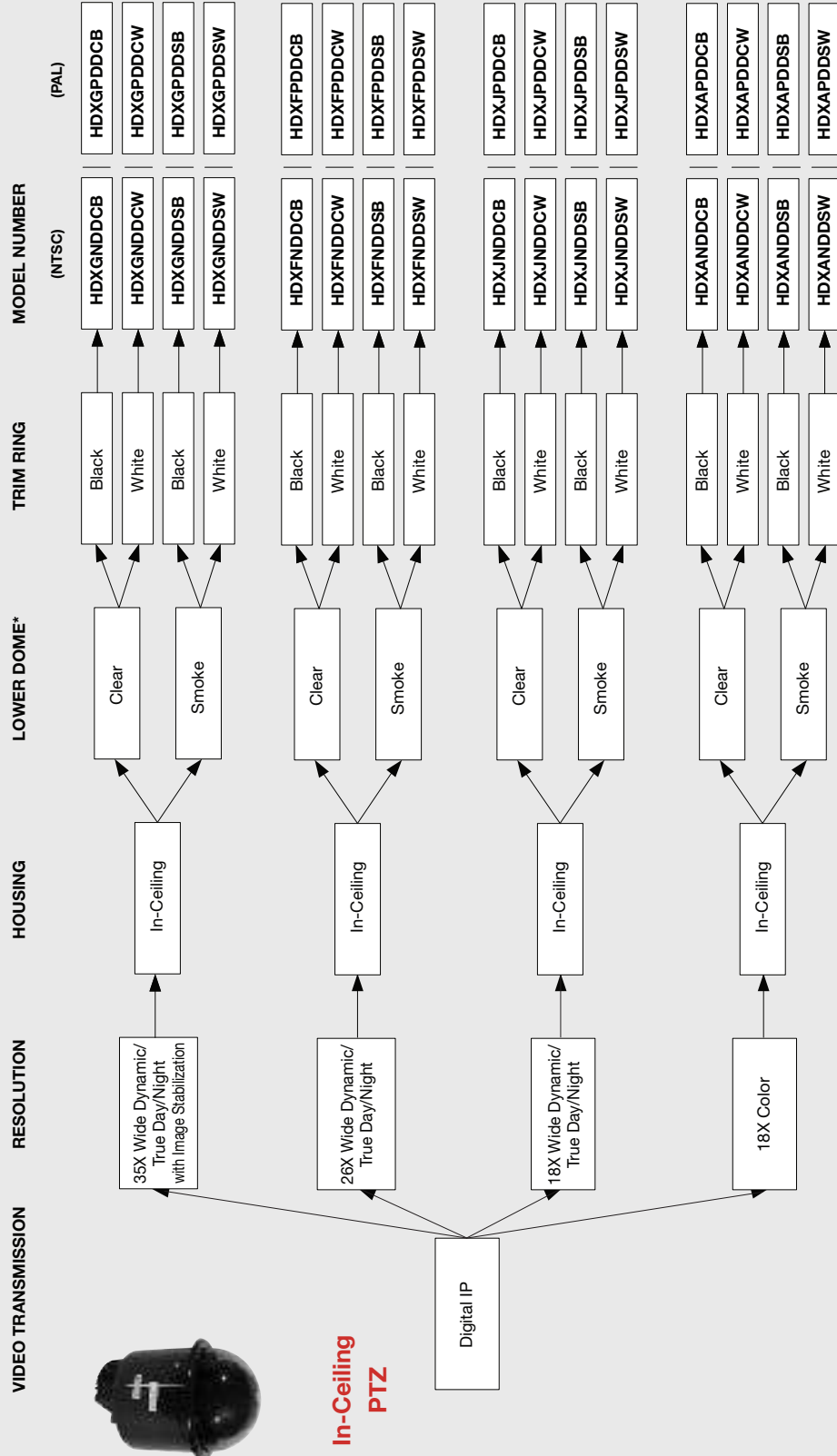

*Gold and chrome options also available.

Note: ACUIX IP and ACUIX input voltage – 24VAC
ACUIX ES input voltage – 12VDC/ 24VAC

Box Cameras

Dome Cameras

PTZ Cameras

IR Cameras

Housing, Mounts & Lenses

Special Purpose Cameras

Recording Solutions

Management Software & Systems

System Components

IP Cameras

ACUIX IP PTZ

ACUIX IP PTZ Cameras

Indoor Pendant PTZ

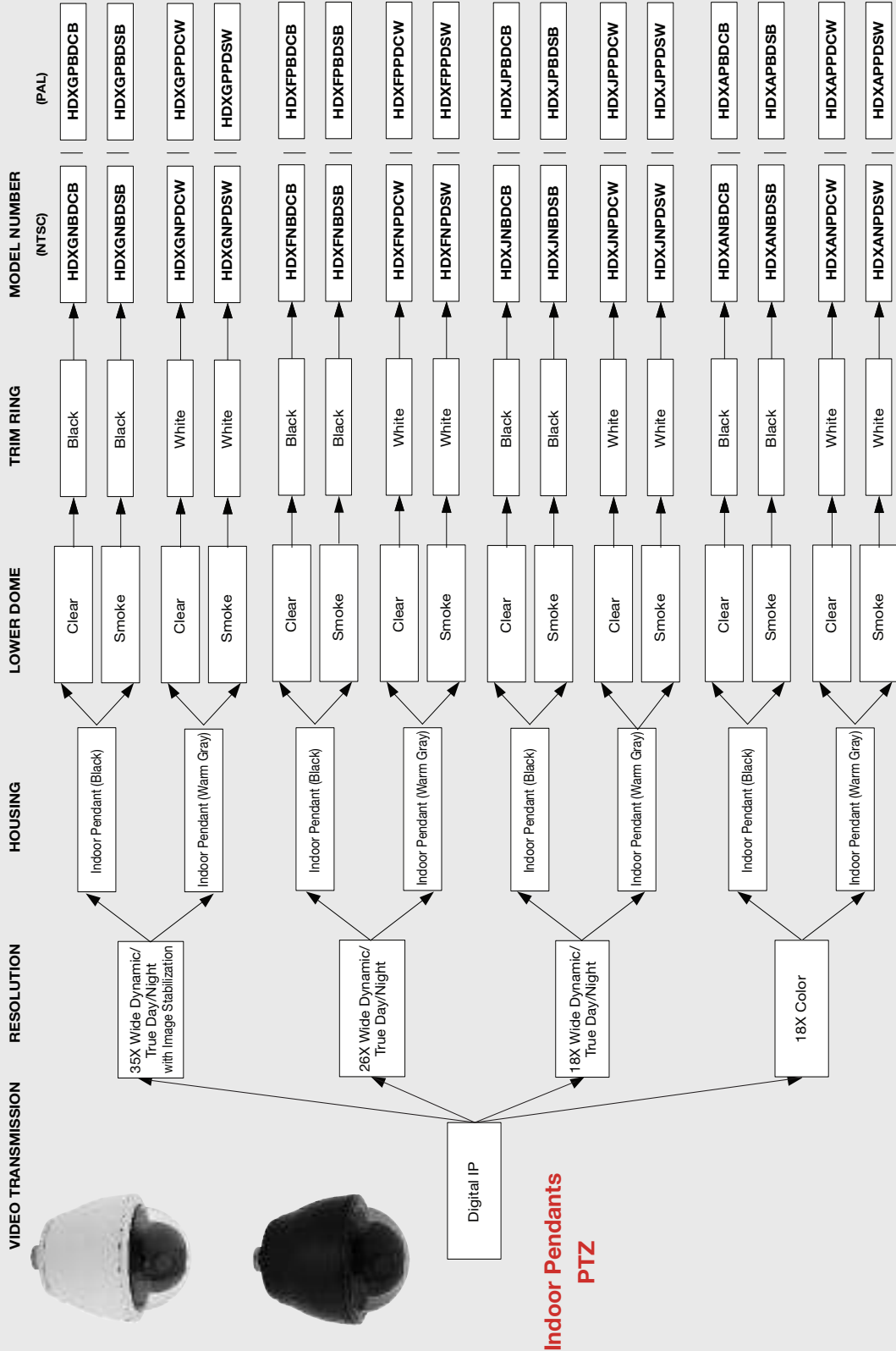

Note: ACUIX IP and ACUIX input voltage – 24VAC
 ACUIX ES input voltage – 12VDC/ 24VAC

IP Cameras

ACUIX IP PTZ

ACUIX IP Cameras PTZ

Outdoor Pendant PTZ

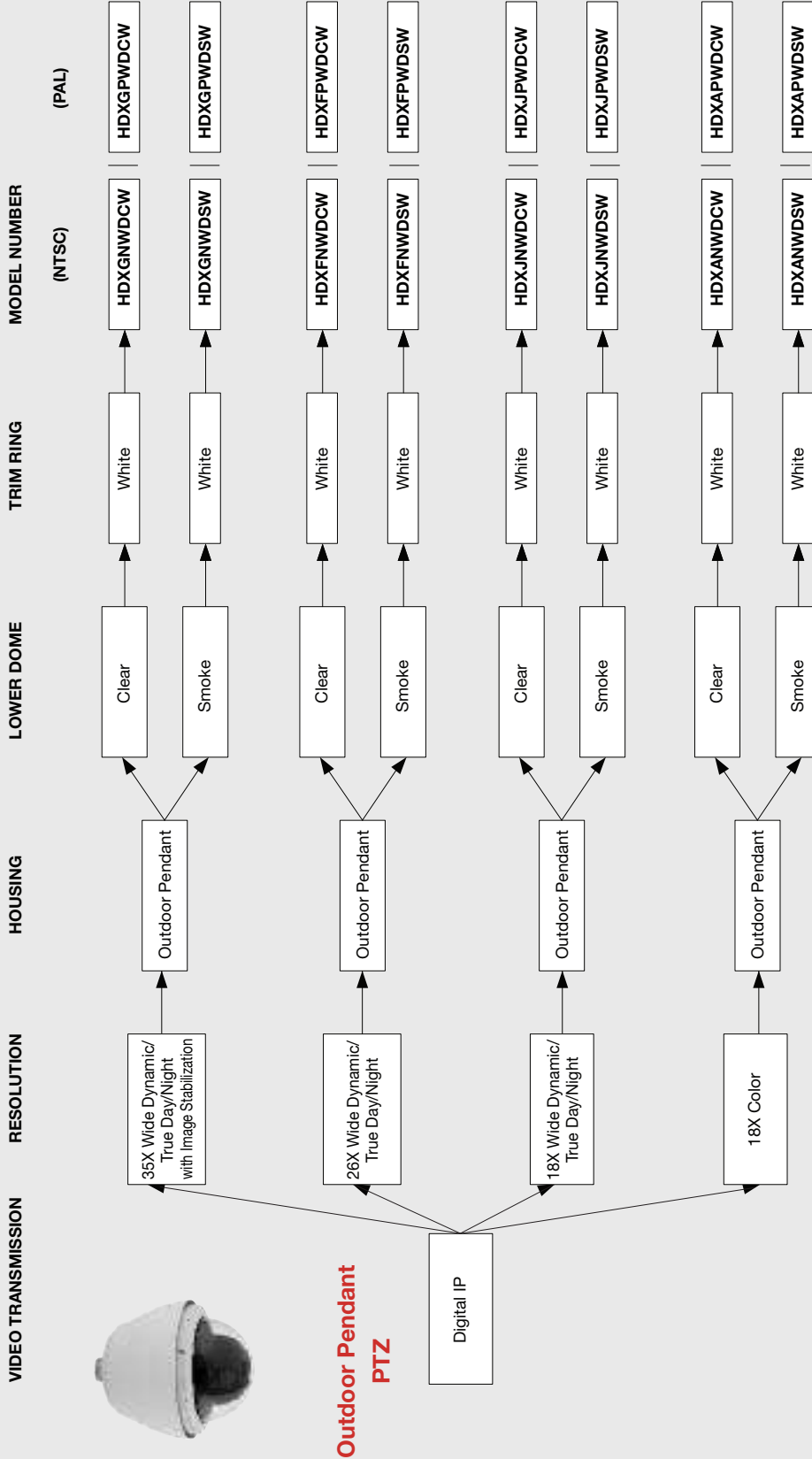

Note: ACUIX IP and ACUIX input voltage – 24VAC
ACUIX ES input voltage – 12VDC/ 24VAC

IP Cameras

ACUIX IP PTZ

ACUIX IP Cameras PTZ

Rugged PTZ

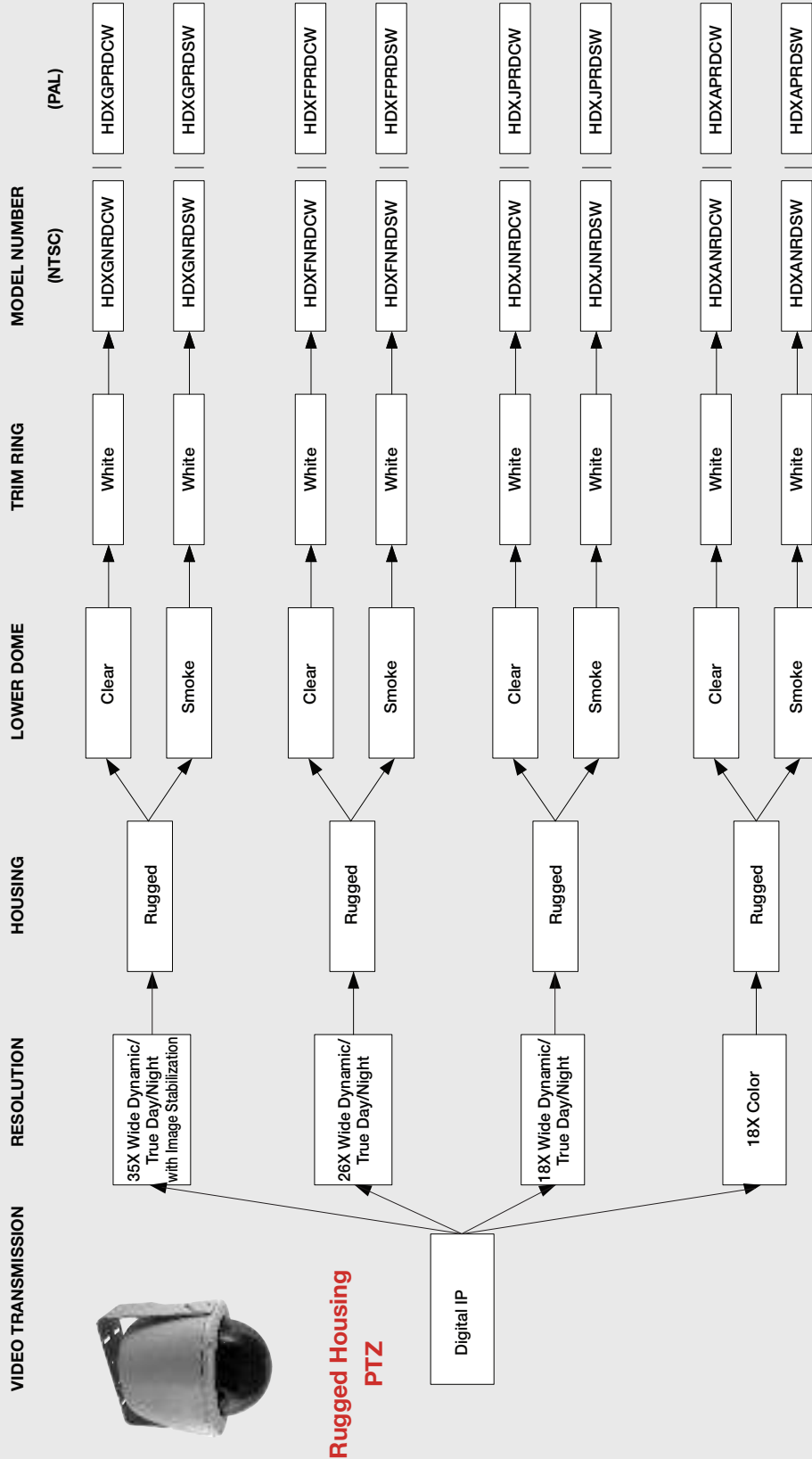

Note: ACUIX IP and ACUIX input voltage – 24VAC
ACUIX ES input voltage – 12VDC/ 24VAC



Box Cameras

Honeywell provides a comprehensive line of box cameras that offers the flexibility and versatility required by the most demanding customer. Our box cameras come in a variety of configurations and with a multitude of options, including Ultra Wide Dynamic, True Day/Night, high resolution color and miniature form factor. Incredibly versatile, each can be mounted in various ways with one of several lens options.

THIS SECTION INCLUDES:

- Color Cameras
- Day/night Cameras
- Wide Dynamic Cameras
- Wide Dynamic + Day/Night Cameras
- Wide Dynamic + True Day/Night Cameras

- IP Cameras
- Box Cameras**
- Dome Cameras
- PTZ Cameras
- IR Cameras
- Housing, Mounts & Lenses
- Special Purpose Cameras
- Recording Solutions
- Management Software & System Solutions
- System Components

Box Cameras

BOX CAMERAS

Honeywell provides a comprehensive line of box cameras that offers the flexibility and versatility required by the most demanding customer. Our box cameras come in a variety of configurations and with a multitude of options, including Ultra Wide Dynamic, True Day/Night, high resolution color and miniature form factor. Incredibly versatile, each can be mounted in various ways with one of several lens options.

Color



HCC484TP (NTSC) | HCC484TPX (PAL)

1/3" CCD, High Resolution Color Camera with DSP, BMB control, 480 TVL, 12VDC/ 24VAC

Day/night



HCS544 (NTSC) | HCS544X (PAL)

1/3" CCD, Super High Resolution Day/Night Camera, 540 TVL, PAL, 12VDC/ 24VAC

True Day/night



HCD545X (PAL)

1/3" CCD High Resolution True Day/Night Camera with DSP, 540 TVL, 0.3 lux, 230V, 12VDC/ 24VAC



HCD544PVX (PAL)

1/3" CCD High Resolution True Day/Night Camera with DSP, 540 TVL, 0.3 lux, 12 VDC/24 VAC

Wide Dynamic



HCU484 (NTSC) | HCU484X (PAL)

1/3" CCD, High Resolution Ultra Wide Dynamic Camera, RS485, 480 TVL, 0.4 lux, 12 VDC/24 VAC

Box Cameras

WIDE DYNAMIC + DAY/NIGHT

Wide Dynamic +Day/Night



HCC-965P-VR (PAL)

Day & Night, Wide Dynamic, 3D-DNR, , 650TVL, 0.001lx, Motion Dection, D. Zoom(x256), RS-485, DC12V/AC24V



HCC-960N-VR (NTSC) | HCC-960P-VR (PAL)

Day&Night, Wide Dynamic, 3D-DNR, 650TVL, 0.001lx, Motion Dection, D. Zoom(x256), RS-485, DC12V



HCC-295P (PAL)

Day & Night, Wide Dynamic, 3D DNR, BLC, BMB, 1/2" CCD, 540TVL, 0.0001lx, AC24V/DC12V



HCC-290N-E (NTSC) | HCC-290P-E (PAL)

Day&Night, Wide Dynamic, 3D DNR, BLC, BMB, 1/2" CCD, 540TVL, 0.0001lx, DC12V



HCC-860NA-E (NTSC) | HCC-860PA-E (PAL)

Day & Night, Wide Dynamic, BMB, icore TM ISP, 540TVL, 0.001lx, DC12V



VCC-600P (PAL)

1/3" CCD, High Resolution Color Camera, 540 TVL, SDN, WDR, 12 VDC

IP Cameras

Box Cameras

Dome Cameras

PTZ Cameras

IR Cameras

Housing, Mounts & Lenses

Special Purpose Cameras

Recording Solutions

Management Software & System Solutions

System Components

Box Cameras

WIDE DYNAMIC + TRUE DAY/NIGHT

Wide Dynamic + True Day/Night



HZC-363N-VR (NTSC) | HZC-363P-VR (PAL)

1/4" Sony Super HAD CCD, True Day&Night, Wide Dynamic, DNR, icore™ ISP, Optical x36 (Max 576x), 520TVL, 0.0001, f=3.4-122.4mm 12VDC



HZC-362N-VR (NTSC) | HZC-362P-VR (PAL)

1/4" Sony Super HAD CCD, True Day&Night, Wide Dynamic, DNR, icore™ ISP, Optical x36 (Max 576x), 520TVL, 0.0001 lx, f=3.6-129.6mm 12VDC



HZC-252N-VR (NTSC) | HZC-252P-VR (PAL)

1/3" CCD, True Day&Night, Wide Dynamic, DNR, icore™ ISP, Optical x25 (Max 400x), 520TVL, 0.0001 lx, 12VDC



HCC-695PTA (PAL)

1/3" CCD, True Day&Night, Wide Dynamic, 3D-DNR, BLC, BMB, icore™ ISP, 540TVL, 0.0001lx, AC24V/DC12V



HCC-690NTA-E (NTSC) | HCC-690PTA-E (PAL)

1/3" CCD, True Day&Night, Wide Dynamic, 3D DNR, BLC, BMB, icore™ ISP, 540TVL, 0.0001lx, DC12V

HCC-690NA-E (NTSC) | HCC-690PA-E (PAL)

1/3" CCD, True Day&Night, Wide Dynamic, 3D DNR, BLC, BMB, icore™ ISP, 540TVL, 0.001lx, DC12V



HCC-890NT (NTSC) | HCC-890PT (PAL)

1/3" CCD, True Day& Night, Wide Dynamic, BMB, icore™ ISP, 540TVL, 0.0001lx, DC12V



Dome Cameras

Mini-Domes are all-inclusive units, combining camera, lens, and housing into a single package that is easy to install, and a good fit for retail and commercial applications. Honeywell's mini-domes are available in many different sizes, lens options and other configurations.

THIS SECTION INCLUDES:

- Indoor Mini Dome Cameras
- Outdoor Mini Dome Cameras

- IP Cameras
- Box Cameras
- Dome Cameras**
- PTZ Cameras
- IR Cameras
- Housing, Mounts & Lenses
- Special Purpose Cameras
- Recording Solutions
- Management Software & System Solutions
- System Components

Dome Cameras | INDOOR MINI-DOMES

INDOOR MINI-DOMES

Color



HD3CB (NTSC) | HD3CBX (PAL)
1/3" CCD Standard Resolution Color Dome Camera, Black Housing, 350 TVL, 2.8 - 10 mm VFAI, 12VDC/ 24VAC



HD40 (NTSC) | HD40X (PAL)
1/3" CCD Standard Resolution Indoor Dome Camera, 380 TVL, Fixed 3.8 mm, 12 VDC

Day/Night



HD3CHS (NTSC) | HD3CHSX (PAL)
1/3" CCD High Resolution, Day/Night Indoor Dome Camera, Off White Housing, 540 TVL, 2.8-10.5 mm VFAI, 12VDC/ 24VAC

True Day/Night



HD3D (NTSC) | HD3DX (PAL)
1/3" CCD High Resolution True Day/Night Dome Camera, Off White Housing, 540 TVL, 2.8 - 10 mm VFAI, 12VDC/ 24VAC



HD3DB (NTSC) | HD3DBX (PAL)
1/3" CCD High Resolution True Day/Night Dome Camera, Black Housing, 540 TVL, 2.8 - 10 mm VFAI, 12VDC/ 24VAC

Wide Dynamic + Day/Night



HD3U (NTSC) | HD3UX (PAL)
1/3" Ultra Wide Dynamic, Indoor Day/Night Dome Camera, Off-White Housing, 540 TVL, 2.8-10.5 mm VFAI, 12VDC/ 24VAC



VDC-600P-36 (PAL)
1/3" CCD, Ultra High Resolution Fixed Dome Camera, 540 TVL, SDN, WDR, 3.6mm fixed lens, 12 VDC

VDC-600P-60 (PAL)
1/3" CCD, Ultra High Resolution Fixed Dome Camera, 540 TVL, SDN, WDR, 6mm fixed lens, 12 VDC

VDC-600PV (PAL)
1/3" CCD, Ultra High Resolution Fixed Dome Camera, 540 TVL, SDN, WDR, 4-9mm varifocal lens, 12 VDC

Dome Cameras | OUTDOOR MINI-DOMES

IP Cameras

Box Cameras

Dome Cameras

PTZ Cameras

IR Cameras

Housing, Mounts & Lenses

Special Purpose Cameras

Recording Solutions

Management Software & System Solutions

System Components

OUTDOOR MINI-DOMES

Color



HD51 (NTSC) | HD51X (PAL)
 1/3" CCD Super High Resolution Vandal Resistant Dome Camera, 550TVL, 4-9 mm VFAI Lens, 12 VDC



HVD-505N (NTSC) | HVD-505P (PAL)
 1/3" CCD Vandal Resistant Dome Camera, 480TVL, 0.5lx, 4~9mm, IP66, DC12V

HVD-505N2 (NTSC) | HVD-505P2 (PAL)
 1/3" CCD Vandal Resistant Dome Camera, 480TVL, 0.5lx, 2.6~6.0mm, IP66, DC12V



HD50 (NTSC) | HD50X (PAL)
 Color, Super High Resolution, 3.8mm lens, 12 VDC

Day/Night



HDC-690N-25 (NTSC) | HDC-690P-25 (PAL)
 1/3" CCD, Day&Night, DNR, DSS, 550TVL, 0.002lx, Motion detection, 2.6mm, DC12V

HDC-690N-36 (NTSC) | HDC-690P-36 (PAL)
 1/3" CCD, Day&Night, DNR, DSS, 550TVL, 0.002lx, Motion detection, 3.6mm, DC12V

HDC-690N-60 (NTSC) | HDC-690P-60 (PAL)
 1/3" CCD, Day&Night, DNR, DSS, 550TVL, 0.002lx, Motion detection, 6.0mm, DC12V



HDC-690NV (NTSC) | HDC-690PV (PAL)
 1/3" CCD, Day&Night, DNR, DSS, 550TVL, 0.002lx, Motion detection, 4~9mm, DC12V

HDC-690NV2 (NTSC) | HDC-690PV2 (PAL)
 1/3" CCD, Day&Night, DNR, DSS, 550TVL, 0.002lx, Motion detection, 2.6~6.0mm, DC12V

Dome Cameras | OUTDOOR MINI-DOMES

True Day/Night



HD4D3 (NTSC) | HD4D3X (PAL)

1/3" Sony Super HAD CCD True Day/Night (TDN) Vandal Dome Camera with DNR, 540 TVL, 3.3 – 12mm VFai, 12VDC/ 24VAC

HD4D9 (NTSC) | HD4D9X (PAL)

1/3" Sony Super HAD CCD True Day/Night (TDN) Vandal Dome Camera with DNR, 540 TVL, 9 – 22mm VFai, 12VDC/ 24VAC

Wide Dynamic + Day/Night



HVD-890NV (NTSC) | HVD-890PV (PAL)

1/3" CCD, Day & Night, Wide Dynamic, icore™ ISP, 540TVL, 0.001lx, 2.8~10mm, IP67, DC12V



HDC-860NA-25-E (NTSC) | HDC-860PA-25-E (PAL)

1/3" CCD, Day & Night, Wide Dynamic, BMB, icore™ ISP, 540TVL, 0.001lx, 2.5mm, DC12V

HDC-860NA-36-E (NTSC) | HDC-860PA-36-E (PAL)

1/3" CCD, Day & Night, Wide Dynamic, BMB, icore™ ISP, 540TVL, 0.001lx, 3.6mm, DC12V

HDC-860NA-60-E (NTSC) | HDC-860PA-60-E (PAL)

1/3" CCD, Day & Night, Wide Dynamic, icore™ ISP, 540TVL, 0.001lx, 6.0mm, DC12V



HDC-860NVA-E (NTSC) | HDC-860PVA-E (PAL)

1/3" CCD, Day & Night, Wide Dynamic, BMB, icore™ ISP, 540TVL, 0.001lx, 2.8~10mm, DC12V

Dome Cameras

OUTDOOR MINI-DOMES

Wide Dynamic + True Day/Night



HD4U (NTSC) | HD4UX (PAL)

1/3" Ultra Wide Dynamic, True Day/Night Dome Camera, Off White Housing, 540 TVL, 2.8-10 mm VFAI, 12VDC/ 24VAC



HVD-890NT (NTSC) | HVD-890PT (PAL)

1/3" True Day & Night, Wide Dynamic, BMB, icore™ ISP, 540TVL, 0.0001lx, 2.8~10mm, IP67, DC12V



HDC-890NVA-E (NTSC) | HDC-890PVA-E (PAL)

1/3" True Day&Night, Wide Dynamic, icore™ ISP, 540TVL, 0.0001lx, 2.8~10mm, DC12V

- IP Cameras
- Box Cameras
- Dome Cameras**
- PTZ Cameras
- IR Cameras
- Housing, Mounts & Lenses
- Special Purpose Cameras
- Recording Solutions
- Management Software & System Solutions
- System Components



PTZ Cameras

Honeywell manufactures a full line of leading-edge PTZ domes that offer world-class performance and seamless system integration.

ACUIX™: The perfect PTZ choice for customers with the most demanding security needs. ACUIX is a feature-rich PTZ loaded with the latest value-added technology for 24/7 active surveillance operations.

ACUIX™ ES: The perfect PTZ choice for customers with applications that require less advanced PTZ features. ACUIX ES has the most popular functionality without the added expense of more advanced PTZ domes. ACUIX ES is competitively priced, so you don't pay for features you don't need.

All ACUIX PTZs feature Honeywell's IntelliBus™ technology that allows users to remotely upload firmware to all domes and permits secure storage of all camera settings such as labels, presets, tours, and privacy zones to the head end.

THIS SECTION INCLUDES:

- ACUIX Series
- ACUIX ES Series
- Performance HDT Series
- Vista Series
- Scandome III Series

PTZ Cameras

ACUIX SERIES

ACUIX SERIES

ACUIX PTZs



ACUIX
In-Ceiling



ACUIX
Indoor Pendant Warm Gray



ACUIX
Indoor Pendant Black



ACUIX
Outdoor Pendant



ACUIX
Rugged Housing

ACUIX ES PTZs



ACUIX ES
In-Ceiling



ACUIX ES
Surface Mount



ACUIX ES
Indoor Pendant



ACUIX ES
Outdoor Pendant

IP Cameras

Box Cameras

Dome Cameras

PTZ Cameras

IR Cameras

Housing, Mounts & Lenses

Special Purpose Cameras

Recording Solutions

Management Software & System Solutions

System Components

PTZ Cameras

ACUIX SERIES

ACUIX PTZs

Housing Style	Camera						Housing Color		Dome and Trim Ring				
	36X TDN WDR EIS	35X TDN WDR EIS	26X TDN WDR	18X TDN WDR	18X Color	Fixed 5-50 mm Vari-focal Auto Iris and Manual Iris	Fixed 2.8-10 mm Vari-focal Auto Iris	Warm Gray	Black	White Trim Ring	Black Trim Ring	Smoke Dome	Clear Dome
ACUIX													
In-Ceiling		•	•	•	•	•				•	•	•	•
Indoor Pendant		•	•	•	•	•		•		•	•	•	•
Outdoor Pendant		•	•	•	•	•		•		•		•	•
Rugged		•	•	•	•	•		•		•		•	•
ACUIX ES													
In-Ceiling					•		•			•		•	•
Indoor Surface Mount					•		•	•				•	•
Indoor Pendant (Surface Mount converted via top cap)					•		•	•				•	•
Outdoor Pendant	•		•		•			•				•	•
ACUIX IP – see pages 2 to 8 for more information													

TDN –True Day/Night
WDR –Wide Dynamic Range
EIS –Electronic Image Stabilization

PTZ Cameras

ACUIX SERIES

ACUIX PTZ Cameras

In-Ceiling PTZ

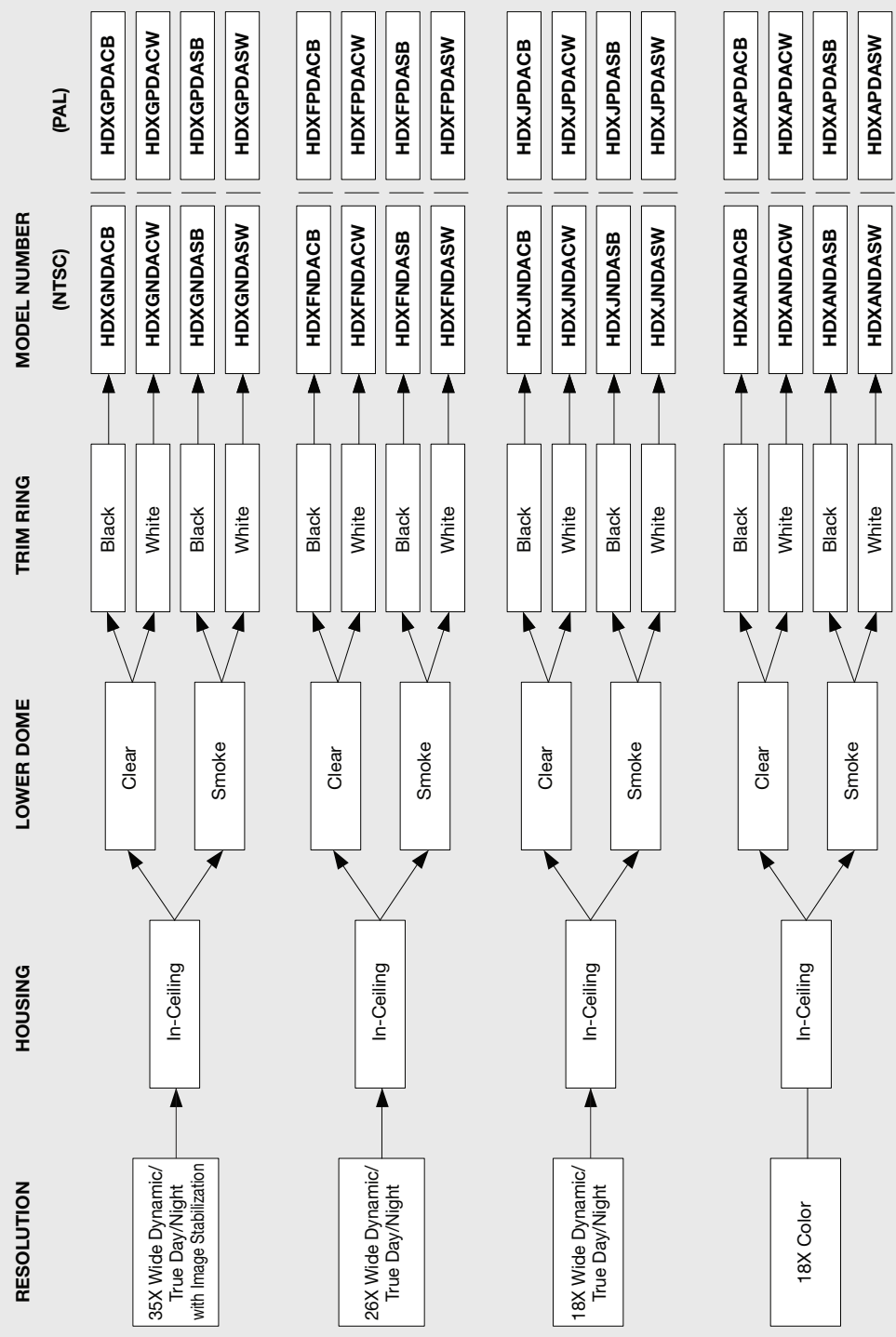

ACUIX
In-Ceiling
PTZ

Note: ACUIX IP and ACUIX input voltage – 24VAC
ACUIX ES input voltage – 12VDC/ 24VAC

- System Components
- Management/Software & System Solutions
- Recording Solutions
- Special Purpose Cameras
- Housing, Mounts & Lenses
- IR Cameras
- PTZ Cameras
- Dome Cameras
- Box Cameras
- IP Cameras

PTZ Cameras

ACUIX SERIES

ACUIX PTZ Cameras

Indoor Pendant PTZ

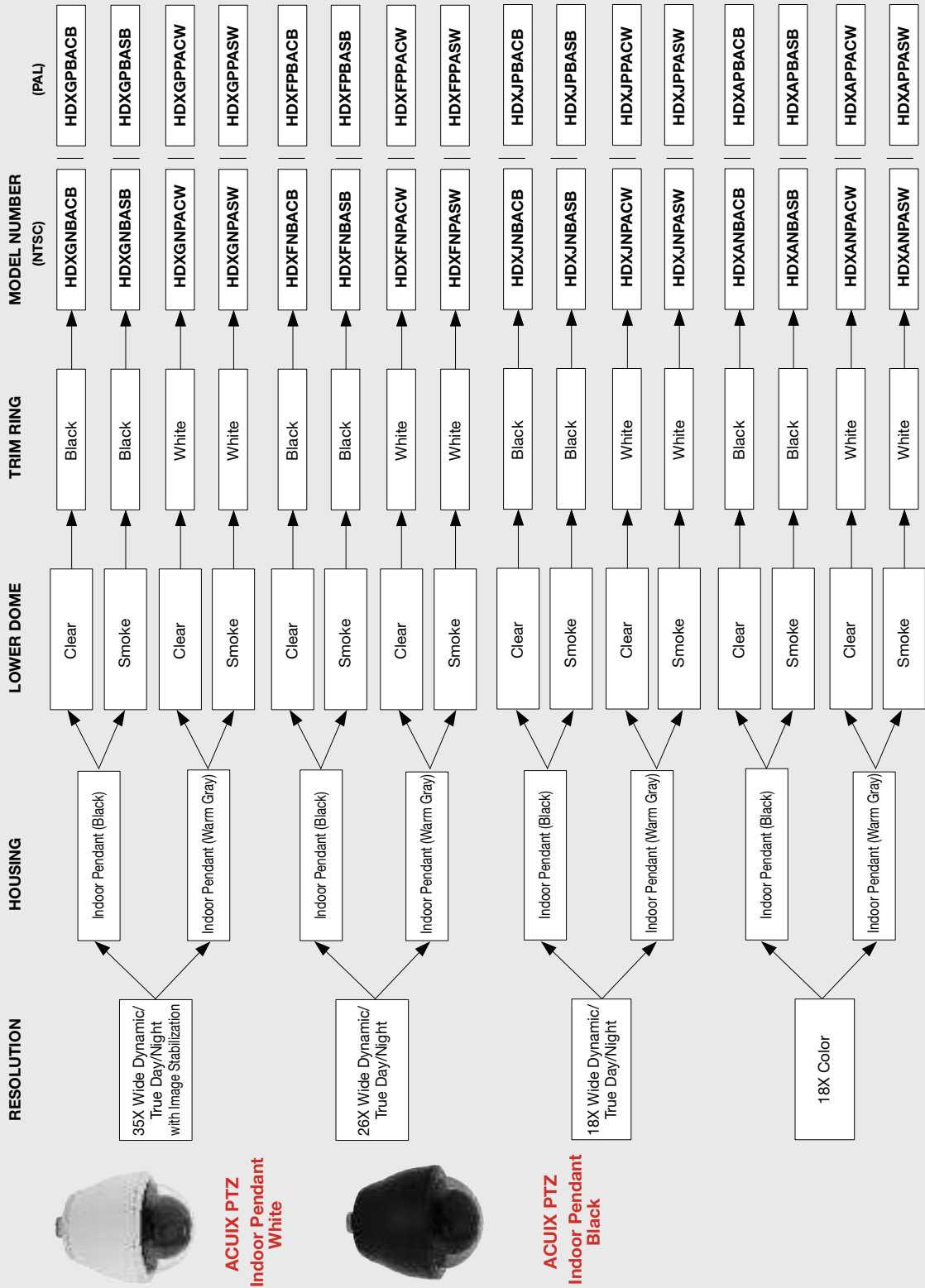

**ACUIX PTZ
Indoor Pendant
White**



**ACUIX PTZ
Indoor Pendant
Black**

Note: ACUIX IP and ACUIX input voltage – 24VAC
ACUIX ES input voltage – 12VDC/ 24VAC

PTZ Cameras

ACUIX SERIES

ACUIX PTZ Cameras

Outdoor Pendant PTZ

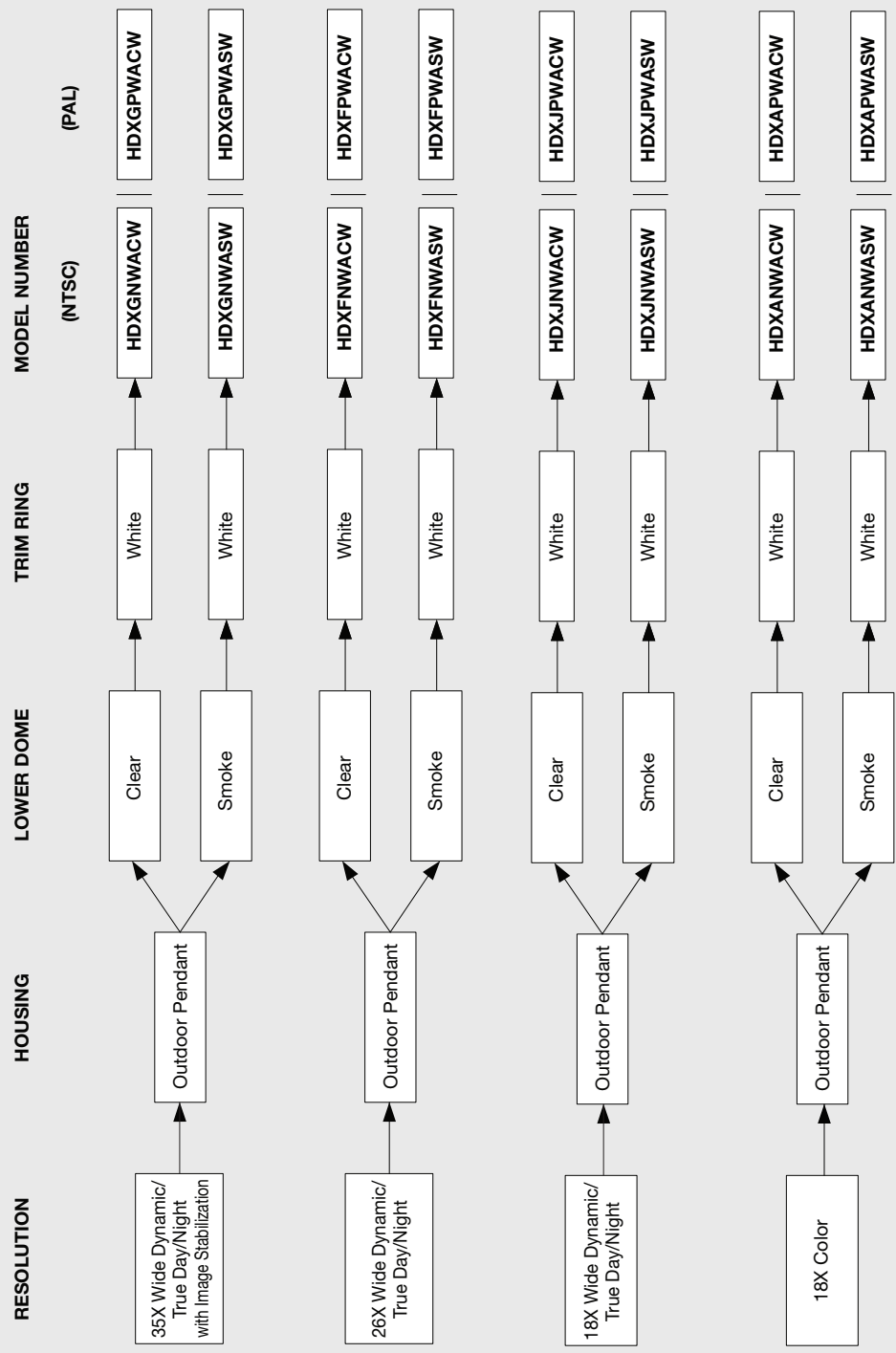

**ACUIX PTZ
Outdoor Pendant**

Note: ACUIX IP and ACUIX input voltage – 24VAC
ACUIX ES input voltage – 12VDC/ 24VAC

- System Components
- Management Software & System Solutions
- Recording Solutions
- Special Purpose Cameras
- Housing, Mounts & Lenses
- IR Cameras
- PTZ Cameras
- Dome Cameras
- Box Cameras
- IP Cameras

PTZ Cameras

ACUIX SERIES

ACUIX Cameras PTZ

Rugged PTZ

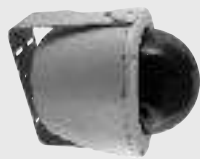
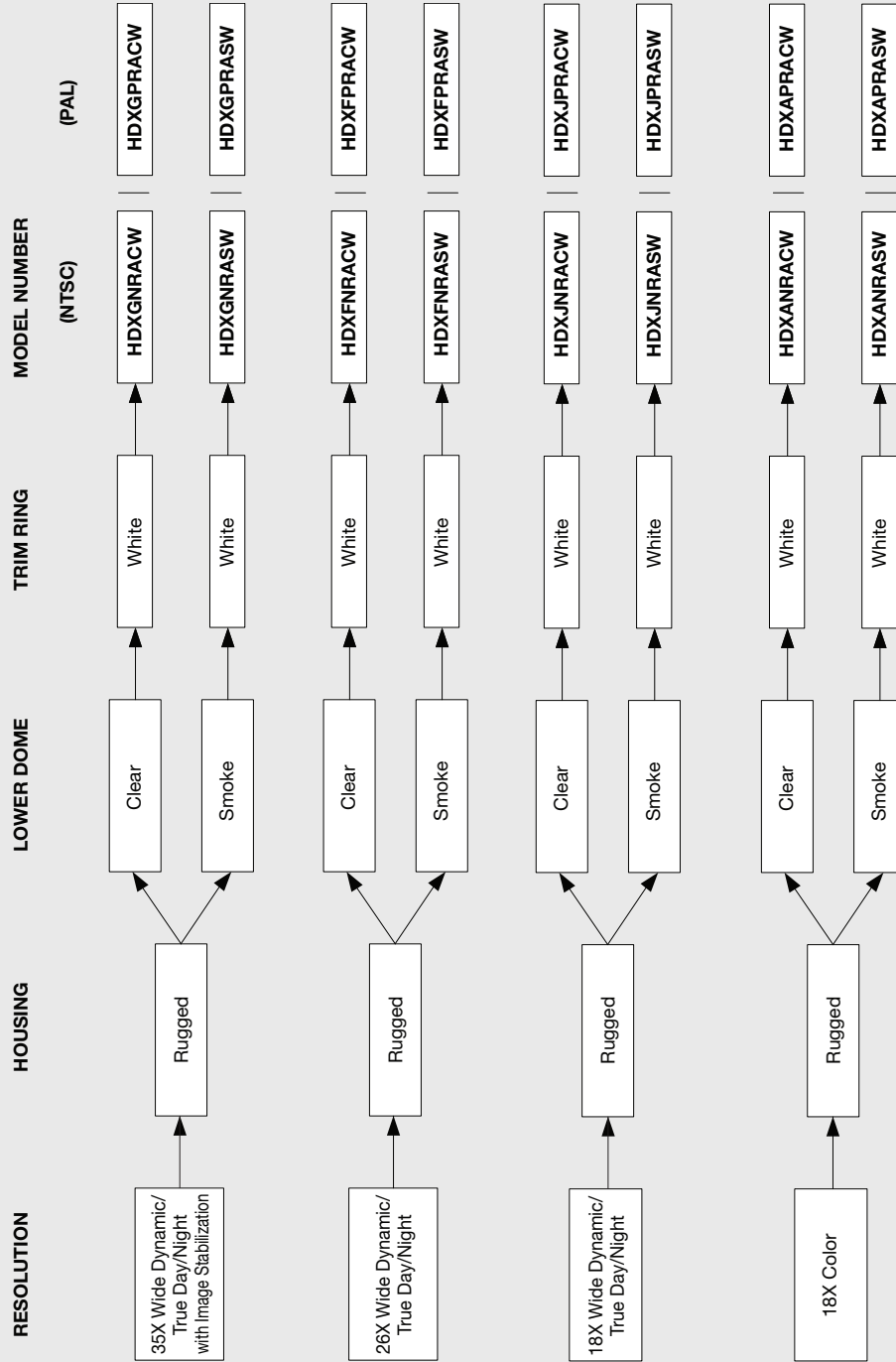

**ACUIX Rugged
PTZ**

Note: ACUIX IP and ACUIX input voltage – 24VAC
ACUIX ES input voltage – 12VDC/ 24VAC

PTZ Cameras

ACUIX ES SERIES

In-Ceiling, Surface Mount, Indoor Pendant PTZ

ACUIX ES PTZ Cameras

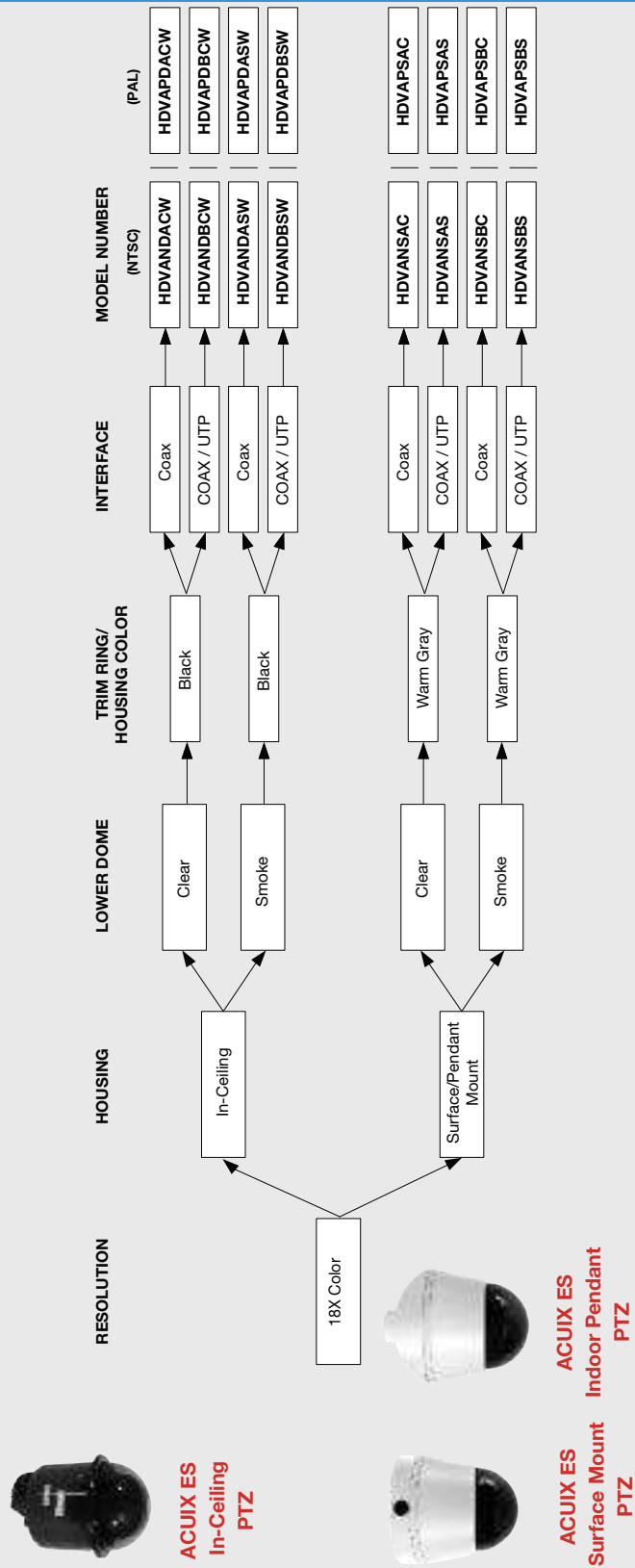

**ACUIX ES
In-Ceiling
PTZ**



**ACUIX ES
Surface Mount
PTZ**



**ACUIX ES
Indoor Pendant
PTZ**

Note: ACUIX IP and ACUIX input voltage – 24VAC
ACUIX ES input voltage – 12VDC/ 24VAC

System
Components

Management Software
& System Solutions

Recording Solutions

Special Purpose
Cameras

Housing, Mounts &
Lenses

IR Cameras

PTZ Cameras

Dome Cameras

Box Cameras

IP Cameras

PTZ Cameras

ACUIX ES SERIES

ACUIX ES PTZ Cameras

Outdoor Pendant PTZ



**ACUIX ES
Outdoor Pendant
PTZ**

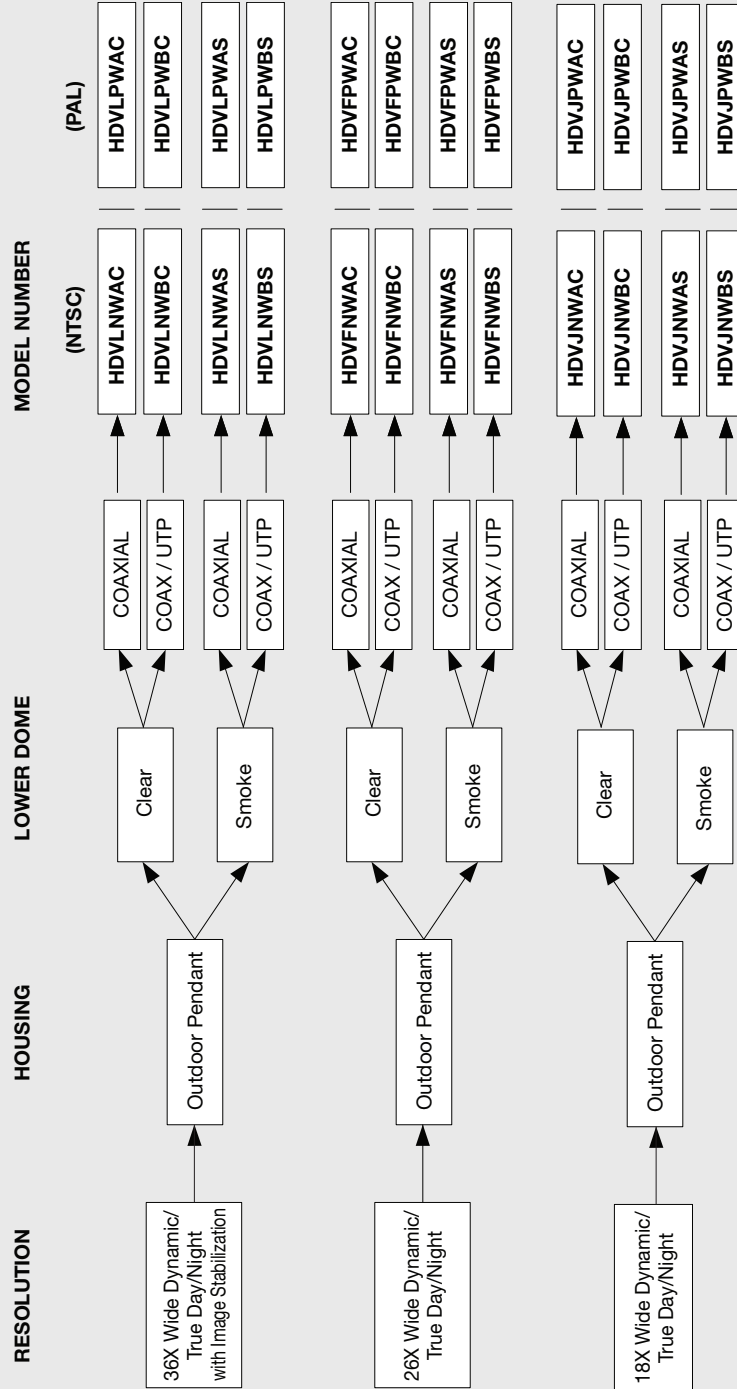

Note: ACUIX IP and ACUIX input voltage – 24VAC
ACUIX ES input voltage – 12VDC/ 24VAC

PTZ Cameras

PERFORMANCE INDOOR / VISTA SERIES

- IP Cameras
- Box Cameras
- Dome Cameras
- PTZ Cameras**
- IR Cameras
- Housing, Mounts & Lenses
- Special Purpose Cameras
- Recording Solutions
- Management Software & System Solutions
- System Components

Performance Indoor PTZ

NEW!



HDT (NTSC) | HDTX (PAL)

10X TDN • Indoor • 3.8-38mm lens F1.8 • 470 TVL (Color) • In-Ceiling, Ceiling, Surface, Wall Mount • Up to 127 user-defined presets, 12VDC/ 24VAC

Brackets

HDTW

Indoor Wall Mount Bracket

HDTX

Indoor Ceiling Mount Bracket

Vista Series

Indoor PTZ

NEW!



VSD-100P (PAL)

Vista, Indoor PTZ Dome Camera, Optical x10 (Total x160), 540TVL, 0.0001lx, 240preset, 8pattern, 8tour, 8scan, without Fan, PAL, DC12V

Brackets



HSDH-C101-ICL

Ceiling mount bracket for VSD-100P



HSDH-C101-IFL

Flush mount bracket for VSD-100P



HSDH-C101-IWL

Wall mount bracket for VSD-100P

PTZ Cameras | VISTA SERIES

Outdoor PTZ



VSD-101P

VISTA Outdoor PTZ Dome Camera, Optical x10 (Total x160), 540TVL, 0.0001lx, 240preset, 8pattern, 8tour, 8scan, with Fan & Heater, PAL, DC12V

Brackets



HSDH-C101-OCL

Ceiling mount bracket for VSD-101P



HSDH-C101-OSF

Surface mount bracket for VSD-101P



HSDH-C101-OWL

Wall mount bracket for VSD-101P

PTZ Cameras

SCAN DOME III SERIES

Scan Dome III PTZ



HSDC-252NA-E | HSDC-252PA-E

icore™ ISP, Optical x25 (Max 400x), 520TVL, 0.0001 lx, TDN, WDR, DNR Multi-protocol, 248 preset (Max. 380°/sec), 8 tour, 4 patterns, 16 Auto Scan / 1 Auto Pan, 24VAC



HSDC-362NA-E (NTSC) | HSDC-362PA-E (PAL)

icore™ ISP, Optical x36 (Max 576x), 520TVL, 0.0001 lx, TDN, WDR, DNR, Multi-protocol, 248 preset (Max. 380°/sec), 8 tour, 4 patterns, 16 Auto Scan / 1 Auto Pan, 24VAC

HSDC-363NA | HSDC-363PA

icore™ ISP, Optical x36 (Max 576x), 520TVL, 0.0001 lx, TDN, WDR, DNR, Multi-protocol, 248 preset (Max. 380°/sec), 8 tour, 4 patterns, 16 Auto Scan / 1 Auto Pan, 24VAC

Scan Dome III Housing



HSDH-602F
Flush Mount Housing



HSDH-602
Indoor Housing



HSDH-602SH
Outdoor Housing w/sun shield, fan & heater



HSDH-602SH67
Outdoor housing for HSDC-371/351/251 Series, Built-in sun-shield, fan & heater



HSDH-CL
Ceiling Mount Bracket



HSDH-WL
Wall mount Bracket



HSDH-CN
Corner Mount Bracket



HSDH-PL
Pole Mount Bracket

HSDH-PR
Roof top Mount Bracket

- IP Cameras
- Box Cameras
- Dome Cameras
- PTZ Cameras
- IR Cameras
- Housing, Mounts & Lenses
- Special Purpose Cameras
- Recording Solutions
- Management Software & System Solutions
- System Components



Housing, Mounts & Lenses

Honeywell offers world-class lenses for both indoor and outdoor performance. These lenses provide customers with the ability to see high contrast, clear and detailed pictures of subjects in daylight, low light and near infrared light. Designed with sophisticated optics for superior light gathering and the ability to work seamlessly with our camera line, Honeywell's lenses provide a complete surveillance solution with unsurpassed performance.

THIS SECTION INCLUDES:

- Housing & Mounts
 - Indoor Mini-Domes
 - Indoor/Outdoor Mini-Domes
 - Box Camera Accessories
 - Box Camera Indoor
 - Box Camera Indoor/Outdoor
 - Box Camera Outdoor
 - ACUIX and ACUIX ES
- Lenses
 - Manual
 - Auto Iris
 - IR Connected
 - Zoom

Housing & Mounts

ACCESSORIES FOR CAMERAS

Indoor Mini-Dome Mounts



HD3-MK1

Indoor Mini Dome - Wall/ Pendant Mount Kit, off white



HD3-MKB

Indoor Mini Dome - Wall/ Pendant Mount Kit, black

Indoor/Outdoor Mini-Dome Mounts



HD4-WK

Indoor/Outdoor Mini Dome - Wall Mount Kit, Off White



HD4-PK

Indoor/Outdoor Mini Dome - Pendant Mount Kit, Off White

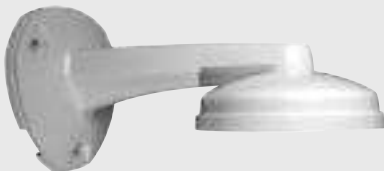

HDPR-WK

Indoor/Outdoor Mini Dome - Wall Mount Kit, Off White



HD4DIP-PK

Indoor/Outdoor Mini Dome - Wall Mount Kit, Off White



ZHD4DIP-WK

Indoor/Outdoor Mini Dome - Pendant Mount Kit, black

IP Cameras

Box Cameras

Dome Cameras

PTZ Cameras

IR Cameras

Housing, Mounts & Lenses

Special Purpose Cameras

Recording Solutions

Management Software & System Solutions

System Components

Housing & Mounts

ACCESSORIES FOR CAMERAS

Box Camera Mounts



HBC5WT

Box camera - Indoor Wall/ Ceiling Mount, white

HBC5BK

Box camera - Indoor Wall/ Ceiling Mount, black

HSB-100B

Wall mount, Load weight 15kg, 331mm

HSB-401

Ceiling mount, Load weight 10kg, 650~1,250mm, I-type



HHMW13 (to be used with HHC1200)

Box camera - Indoor / Outdoor Wall Mount, 13" L 30lb max load
(used with HHC1200)



HHMC21J

Box camera - Indoor / Outdoor Ceiling "J" Mount, 21" H 30lb max load



HHMCMA

Box Camera - Corner mount adapter for HHMW13



HHMPMA

Box Camera - Pole mount adapter for HHMW13

Housing & Mounts

ACCESSORIES FOR CAMERAS

Box - Indoor Housings



GHG-070
Indoor, -15°C~45°C, Inside :
100(W)x80(H)x171(D)mm, 1.0kg



GHG-120
Indoor, -15°C~45°C, Inside :
100(W)x80(H)x290(D)mm, 1.3kg



GHG-140
Indoor, -15°C~45°C, Inside :
100(W)x80(H)x329(D)mm, 1.5kg



GHG-140A
Indoor, -34°C~49°C, Inside :
100(W)x80(H)x345(D)mm, 1.2kg, IP65



GHG-320A
Indoor, -15°C~45°C, Inside :
98(W)x82(H)x322(D)mm, 1.0kg



GHG-340A
Indoor, -15°C~45°C, Inside :
141(W)x101(H)x400(D)mm, 1.5kg

Box - Indoor/Outdoor Housings



GHG-140S
Indoor/Outdoor, -15°C~45°C, Inside :
100(W)x80(H)x329(D)mm, 2.0kg, Sunshield



GHG-210S
Indoor/Outdoor, -35°C~49°C, Inside :
110(W)x100(H)x350(D)mm, 2.8kg, Sunshield

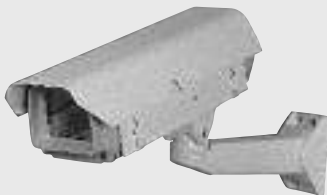

HHC12WM
Box camera - 15" indoor/outdoor enclosure
with mount and sunshield

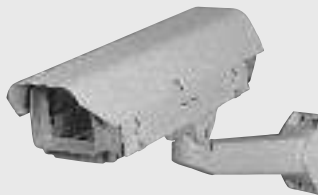

HHC12WM2
Box camera - 15" indoor/outdoor enclosure
with mount, sunshield and 24VAC
heater/blower

IP Cameras

Box Cameras

Dome Cameras

PTZ Cameras

IR Cameras

Housing, Mounts & Lenses

Special Purpose Cameras

Recording Solutions

Management Software & System Solutions

System Components

Housing & Mounts

ACCESSORIES FOR CAMERAS

Box - Outdoor Housings



GHG-140SA

Outdoor, -34°C~49°C, Inside :
100(W)x80(H)x345(D)mm, 1.6kg, IP65,
Sunshield



GHG-140SHBA-024

Outdoor, -35°C~49°C, Inside :
100(W)x80(H)x325(D)mm, 1.8kg, IP65,
Sunshield, Heater, Blower, AC24V



GHG-140SHBA-110

Outdoor, -35°C~49°C, Inside :
100(W)x80(H)x325(D)mm, 1.8kg, IP65,
Sunshield, Heater, Blower, AC110V



GHG-140SHBA-220

Outdoor, -35°C~49°C, Inside :
100(W)x80(H)x325(D)mm, 1.8kg, IP65,
Sunshield, Heater, Blower, AC220V



GHG-210SA

Outdoor, -35°C~49°C, Inside :
120(W)x110(H)x430(D)mm, 2.6kg, IP65,
Sunshield



GHG-210SHB-110

Outdoor, -35°C~49°C, Inside :
110(W)x100(H)x320(D)mm, 3.1kg,
Sunshield, Heater, Blower, AC110V



GHG-210SHB-220

Outdoor, -35°C~49°C, Inside :
110(W)x100(H)x320(D)mm, 3.1kg,
Sunshield, Heater, Blower, AC220V

GHG-210SHBA-024

Outdoor, -35°C~49°C, Inside : 120(W)x110(H)x450(D)mm, 3.4kg, IP65,
Sunshield, Heater, Blower, AC24V

GHG-210SHBA-110

Outdoor, -35°C~49°C, Inside : 120(W)x110(H)x450(D)mm, 3.4kg, IP65,
Sunshield, Heater, Blower, AC110V

GHG-210SHBA-220

Outdoor, -35°C~49°C, Inside : 120(W)x110(H)x450(D)mm, 3.4kg, IP65,
Sunshield, Heater, Blower, AC220V

Housing & Mounts

ACCESSORIES FOR CAMERAS

ACUIX™ and ACUIX™ ES Mounts and Adapters



HDXWM2B
ACUIX and ACUIX ES - Wall mount Indoor/Outdoor, 1.5"NPT, Black matte



HDXWM2
ACUIX and ACUIX ES - Wall mount Indoor/Outdoor, 1.5"NPT, Warm gray



HDCM1
ACUIX and ACUIX ES - Pendant mount, Indoor, 1.5" NPT, Warm gray



HDPRM2
ACUIX and ACUIX ES - Flat roof and parapet mount, Outdoor, 1.5" NPT, Warm gray

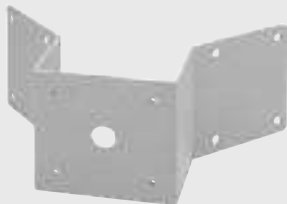

HDXPMA1
ACUIX and ACUIX ES - Corner mount adapter, Indoor, 1.5" NPT, Warm gray (used with HDXWM2 and HDXWM1B)



HDXCMA1
ACUIX and ACUIX ES - Pole mount adapter, Indoor/ Outdoor, 1.5" NPT, Warm gray (used with HDXWM2 and HDXWM1B)

IP Cameras

Box Cameras

Dome Cameras

PTZ Cameras

IR Cameras

Housing, Mounts & Lenses

Special Purpose Cameras

Recording Solutions

Management Software & System Solutions

System Components

Lens | MANUAL IRIS

Manual Iris



GL-M28V100CS

Manual iris, Vari-focal, 2.8-10mm, CS, 1/3"



GL-M35V80CS

Manual iris, Vari-focal, 3.5-8mm, CS, 1/3"



GL-M40V160CS

Manual iris, Vari-focal, 4-16mm, CS, 1/3"



GL-M50V500CS

Manual iris, Vari-focal, 5-50mm, CS, 1/3"



HLM25V6F12

Vari-Focal Manual Iris - System Series



HLM28V8F95

Vari-Focal Manual Iris - System Series



HLM5V50F13

Vari-Focal Manual Iris - System Series

Lens | AUTO IRIS

Auto Iris



HLD25V6F12L
Vari-Focal Auto Iris - System Series



HLD5V50F13L
Vari-Focal Auto Iris - System Series



HLD28V8F95L
Vari-Focal Auto Iris - System Series



GL-D28V100CS
DC iris, Vari-focal, 2.8-10mm, CS, 1/3"



GL-D35V80CS
DC iris, Vari-focal, 3.5-8mm, CS, 1/3"



GL-D50V500CS
DC iris, Vari-focal, 5-50mm, CS, 1/3"



GL-D40V160CS
DC iris, Vari-focal, 4-16mm, CS, 1/3"

- IP Cameras
- Box Cameras
- Dome Cameras
- PTZ Cameras
- IR Cameras
- Housing, Mounts & Lenses
- Special Purpose Cameras
- Recording Solutions
- Management Software & System Solutions
- System Components

Lens | IR CORRECTED

IR Corrected (Recommended for TDN Camera)



HLD29V8DNL
Vari-Focal True day/Night



HLD27V13DNL
Vari-Focal True day/Night



HLD5V50DNL
Vari-Focal True day/Night

Zoom Lenses



GL-3M1027A
Auto iris, Zoom lens, 10-270mm, C-Mount, 1/2"



GL-A100Z10C
Auto iris, Zoom lens, 10-100mm, C-mount, 1/2"



GL-A100Z20
Auto iris, Zoom lens, 10-200mm, C-mount, 1/2"



GL-A60Z10C
Auto iris, Zoom lens, 6-60mm, C-mount, 1/3"



GL-A80Z8C
Auto iris, Zoom lens, 8-64mm, C-mount, 1/2"



GL-A80Z10C
Auto iris, Zoom lens, 8-80mm, C-mount, 1/2"



IR Cameras

Honeywell's discreet and stylish high-quality bullet-style cameras are designed with aesthetics, flexibility and ease of installation in mind. When ambient light drops below a certain point, a mechanical IR cut filter within the camera switches and the camera changes from color to black and white enabling color pictures to be captured by day, and clear black and white images at night. Our industry leading product offering includes models with polished aluminum enclosures, sun hoods, and integrated infrared illuminators.

THIS SECTION INCLUDES:

- IR Bullet Cameras
- IR Dome Cameras

- IP Cameras
- Box Cameras
- Dome Cameras
- PTZ Cameras
- IR Cameras**
- Housing, Mounts & Lenses
- Special Purpose Cameras
- Recording Solutions
- Management Software & System Solutions
- System Components

IR Cameras | BULLET CAMERAS

IR Bullet Cameras

Day/Night

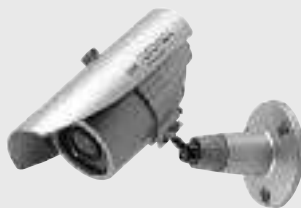

**HB72B (Black), HB72W (White), HB72S (Silver) (NTSC) |
HB72BX (Black), HB72WX (White), HB72SX (Silver) (PAL)**
1/3" CCD Super High Resolution IR Bullet Camera, 530 TVL, 4.3 mm, 12 IR LED, Day/Night, 12VDC

HB70 (NTSC) | HB70X (PAL)
1/3" CCD Super High Resolution IR Bullet Camera, 380 TVL, 4.3 mm, 12 IR LED, Silver, Day/Night, 12VDC

**HB71B (Black), HB71S (Silver) (NTSC) |
HB71BX (Black), HB71SX (Silver) (PAL)**
1/3" CCD Standard Resolution IR Bullet Camera, 380 TVL, 6.0 mm, 34 IR LED, Day/Night, 12VDC

True Day/Night



HCD95534 (NTSC) | HCD95534X (PAL)
1/3" CCD IR Bullet Camera, TDN, 530 TVL, 5-50 mm, 26 IR LED, 12VDC / 24VAC

HCD92534 (NTSC) | HCD92534X (PAL)
1/3" CCD IR Bullet Camera, TDN, 530 TVL, 2.8-10 mm, 49 IR LED, 12VDC / 24VAC



HB73 (NTSC) | HB73X (PAL)
1/3" CCD Super High Resolution IR Bullet Camera, TDN, DNR, 550 TVL, 3.8-9.5 mm, 18 IR LED, 12VDC

IR Cameras | DOME CAMERAS

IR Dome Cameras

Color



HVD-505NI-36 (NTSC) | HVD-505PI-36 (PAL)

Vandal Dome, 18 IR Lamp (0lx with IR On), 550TVL, 0.1lx, 3.6mm, DC12V

HVD-505NI-60 (NTSC) | HVD-505PI-60 (PAL)

Vandal Dome, 0.1lx, 18 IR Lamp (0lx with IR On), 6.0mm, DC12V



HVD-515NI-36 (NTSC) | HVD-515PI-36 (PAL)

Vandal Dome, IR 18 Lamp (0lx with IR On), 550TVL, 0.1lx, 3.6mm, AC24V/DC12V

HVD-515NI-60 (NTSC) | HVD-515PI-60 (PAL)

Vandal Dome, IR 18 Lamp (0lx with IR On), 550TVL, 0.1lx, 6.0mm, AC24V/DC12V

Day/Night



HD60 (NTSC) | HD60X (PAL)

1/3" CCD Integrated Day/Night Standard Resolution IR Fixed Mini Dome Camera, 380 TVL, 24 LEDs, Fixed 4.0 mm, 12 VDC



HD61 (NTSC) | HD61X (PAL)

1/3" CCD Integrated Day/Night Standard Resolution IR Vandal Resistant Dome Camera, 380 TVL, 20 LEDs, 4-9 mm VFMI Lens, 12 VDC



HD70 (NTSC) | HD70X (PAL)

1/3" CCD Integrated Day/Night Super High Resolution IR Vandal Resistant Dome Camera, 550 TVL, 24 LEDs, Fixed 4.0 mm, 12 VDC

- IP Cameras
- Box Cameras
- Dome Cameras
- PTZ Cameras
- IR Cameras**
- Housing, Mounts & Lenses
- Special Purpose Cameras
- Recording Solutions
- Management Software & System Solutions
- System Components

IR Cameras | DOME CAMERAS

True Day/Night



HD73 (NTSC) | HD73X (PAL)

1/3" CCD Integrated True Day/Night Super High Resolution IR Vandal Resistant Dome Camera, 530 TVL, 20 LEDs, 3.8-9.5 mm VFAI Lens, 12 VDC



HD4DIR (NTSC) | HD4DIRX (PAL)

1/3" CCD Integrated True Day/Night High Resolution Color Vandal Resistant Dome Camera with DNR, 540 TVL, 18 LEDs, 3.3-12 mm VFAI, 12 VDC/24 VAC

Wide Dynamic



HVD-890NI (NTSC) | HVD-890PI (PAL)

Vandal Dome, IR, Wide Dynamic, BMB, icore™ ISP, 540TVL, 0lx, 2.8~10mm, IP67, DC12V



HDC-890NVIA-E (NTSC) | HDC-890PVIA-E (PAL)

True Day&Night, Wide Dynamic, BMB, icore™ ISP, 540TVL, 0lx, 2.8~10mm, DC12V

Wide Dynamic + True Day/Night



Special Purpose Cameras

The demand for explosion-proof camera systems is fast growing in the industrial vertical markets. Honeywell special purpose cameras are designed to operate in conditions that would generally endanger normal cameras. Internationally certified, the Honeywell Explosion Proof systems are designed to follow the stringent explosion proof requirements for installation in hazardous locations.

THIS SECTION INCLUDES:

- Explosion Proof PTZ Camera System
- Explosion Proof Fixed Camera System
- Parascan Cameras and Modules

IP Cameras

Box Cameras

Dome Cameras

PTZ Cameras

IR Cameras

Housing, Mounts & Lenses

Special Purpose Cameras

Recording Solutions

Management Software & System Solutions

System Components

Special Purpose Cameras | SYSTEMS

Explosion Proof PTZ Camera System



EXPTZ250N-1 (NTSC)

Built in Pan/Tilt/Receiver, x25 zoom camera, Ex d II T6, SUS316, IP67, AC110V.

EXPTZ250N-2 (NTSC) | EXPTZ250P-2 (PAL)

Built in Pan/Tilt/Receiver, x25 zoom camera, Ex d II T6, SUS316, IP67, AC220V.

EXPTZ250NA (NTSC) | EXPTZ250PA (PAL)

High speed Built in Pan/Tilt/Receiver, x25 zoom camera, IECEx d IIC T6, SUS316, IP67, AC110V ~ 230V.

EXPTZ251N-1 (NTSC)

Built in Pan/Tilt/Receiver, x25 zoom camera & 360° ParaScan, Ex d II T6, SUS316, IP67, AC110V.

EXPTZ251N-2 (NTSC) | EXPTZ251P-2 (PAL)

Built in Pan/Tilt/Receiver, x25 zoom camera & 360° ParaScan, Ex d II T6, SUS316, IP67, AC220V.

EXPTZ251NA (NTSC) | EXPTZ251PA (PAL)

High speed Built in Pan/Tilt/Receiver, x25 zoom camera & 360° ParaScan, IECEx d IIC T6, SUS316, IP67, AC110V ~ 230V.

EXPTZ350NA (NTSC) | EXPTZ350PA (PAL)

High speed Built in Pan/Tilt/Receiver, x35 zoom camera, IECEx d IIC T6, SUS316, IP67, AC110V ~ 230V.

EXPTZ351NA (NTSC) | EXPTZ351PA (PAL)

High speed Built in Pan/Tilt/Receiver, x35 zoom camera & 360° ParaScan, IECEx d IIC T6, SUS316, IP67, AC110V ~ 230V.

Explosion Proof PTZ Mount and Brackets

EXPTZ-CN

Explosion Proof PTZ Corner mount bracket

EXPTZ-PL

Explosion Proof PTZ Pole mount bracket

EXPTZ-SS

Explosion Proof PTZ Sunshield bracket

EXPTZ-WL

Explosion Proof PTZ Wall mount bracket

EXWJ400

Explosion Proof PTZ Washer Set (only for High-speed EXPTZ)

Explosion Proof Fixed Camera System

Camera Module



EXH220N-25 (NTSC) | EXH220P-25 (PAL)

Built-in x25 Zoom Camera, 480TVL, TDN, DSS, BMB

EXH220N-35 (NTSC) | EXH220P-35 (PAL)

Built-in x35 Zoom Camera, 480TVL, TDN, DSS, BMB

EXH220NW-25 (NTSC) | EXH220PW-25 (PAL)

Built-in x25 Zoom Camera, 480TVL, TDN, DSS, BMB, Wiper

EXH220NW-35 (NTSC) | EXH220PW-35 (PAL)

Built-in x35 Zoom Camera, 480TVL, TDN, DSS, BMB, Wiper



MORE ADDITIONS TO OUR EXPLOSION PROOF RANGE

Special Purpose Cameras | SYSTEMS

Explosion Proof PTZ Mount and Brackets



EXB220-C
Ceiling mount type bracket for EHX220 series

EXB220-W
Wall mount type bracket for EHX220 series

Pan/Tilt Driver



GPT-350-110
Outdoor, Weather proof, Max load 30kg, AC110V

GPT-350-220
Outdoor, Weather proof, Max load 30kg, AC220V

Parascan Cameras and Modules



HPSC-090N-A3 (NTSC) | HPSC-090P-A3 (PAL)
Parascan, 90° view camera, 470TVL, 0.3lx, DC12V

HPSC-180N-A3 (NTSC) | HPSC-180P-A3 (PAL)
Parascan, 180° view camera, 470TVL, 0.3lx, DC12V

Housings



HPSH-360
Indoor housing for 360° view
HPSH-360SH
Outdoor housing for 360° view
HPSH-360F
Flush mount for 360° view

Modules



HPSM-090N-A3 (NTSC) | HPSM-090P-A3 (PAL)
Parascan, 90° view module, 470TVL, 0.3lx, DC12V
HPSM-180N-A3 (NTSC) | HPSM-180P-A3 (PAL)
Parascan, 180° view module, 470TVL, 0.3lx, DC12V

Image Mixer



HPSQ-502B
Image mixer, 5-video input, PIP

- IP Cameras
- Box Cameras
- Dome Cameras
- PTZ Cameras
- IR Cameras
- Housing, Mounts & Lenses
- Special Purpose Cameras
- Recording Solutions
- Management Software & System Solutions
- System Components

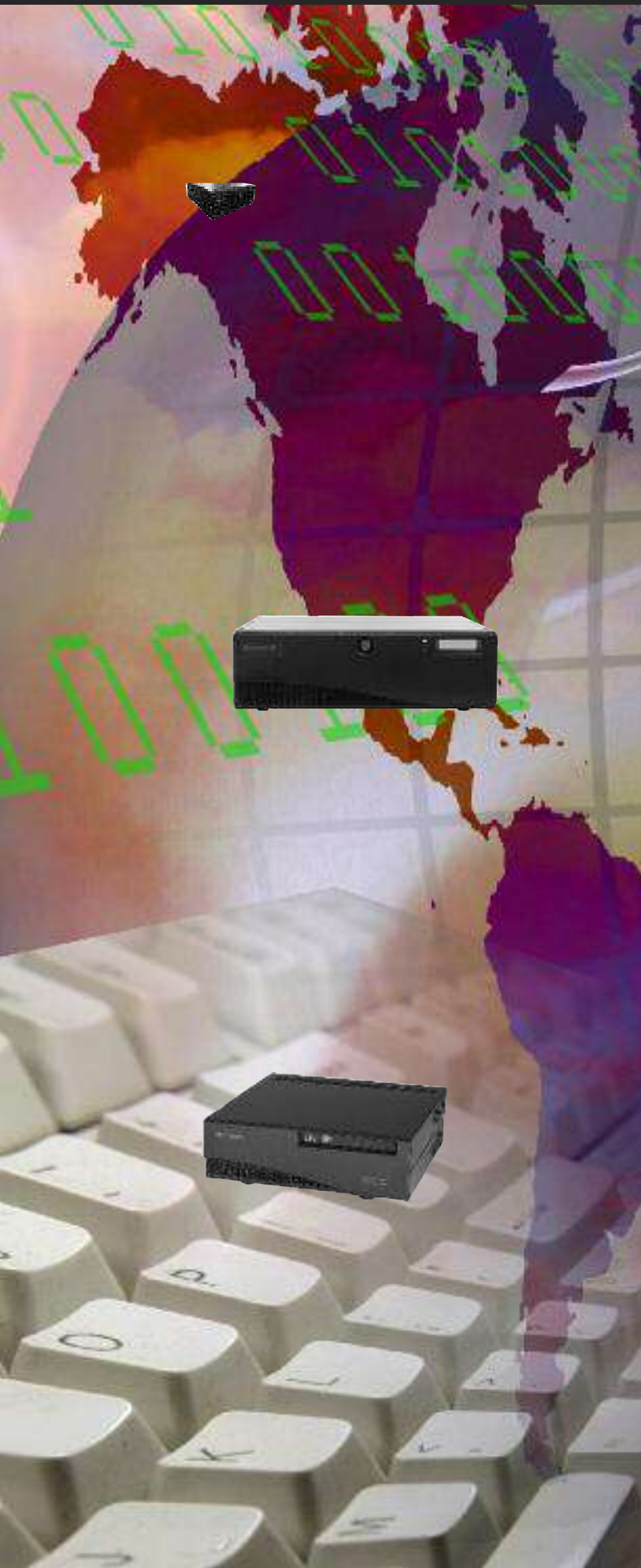

Recording Solutions

The family of Rapid Eye™ DVRs is more versatile than ever. Four powerful hardware platforms perfect for a diverse range of installations.

The Rapid Eye family offers seamless remote operation as well as unprecedented flexibility to meet virtually any need.

The Fusion IV DVR Series is the next step in digital video recording. Expanding beyond the analog DVR role, Fusion IV bridges the gap between DVRs and NVRs. It is a full-featured hybrid digital recording system that is designed to record, search and transmit up to 32 channels of analog or IP video sources and up to 16 channels of audio.

THIS SECTION INCLUDES:

- PC Based Recorders
- Embedded Recorders

Recording Solutions

PC-BASED

Fusion IV DVR

Because choosing the DVR that best fits your application can be a complicated process, we are committed to helping you make the best choice.

Fusion IV DVR is the perfect choice when:

- When your system exceeds 16 cameras
- Integration with either embedded intelligent video or data analytics is required
- A hybrid DVR for a combination of analog and IP cameras is required
- Internal storage requirements upto 8TB
- Seamless integration with Honeywell's WIN-PAK® SE, WIN-PAK® PE, NetAXS™ or Pro-Watch® access control software platforms is desire



Hardware

- Analog and digital IP recording up to a total of 32 channels
- Up to 32 channels digital IP
- Available with 8, 16 or 32 looping analog video inputs
- Global recording rates from 120 to 480 (NTSC) / 100 to 400 (PAL) at CIF resolution
- Recording resolutions up to 720 x 480 (NTSC) / 720x576 (PAL) (4CIF) analog, 5 MP IP
- Real time live video viewing on the display models
- License free substitution of unused analog channels to IP channels
- Internal storage capacity from 500 GB to 8 TB
- External storage options from 1 TB to 48 TB
- 16 sensor inputs and 16 control outputs
- Optional multiplexed or switched spot outputs
- 16 channels of audio standard on select models
- 10/100/1000 standard
- Keyboard control of camera selection and PTZ control
- Windows XP® embedded operating system

Access Control Integration of Fusion IV DVR				
	Typical Applications	Software Solution	Hardware Solution	Video Solution
Large Commercial	<ul style="list-style-type: none"> • Medium/Large Commercial • Financial • Pharmaceutical • Universities/Campuses • Government 	<ul style="list-style-type: none"> • Pro-Watch CE with Maxpro VMS • WIN-PAK PE • WIN-PAK SE 	<ul style="list-style-type: none"> • PW-6000 • NetAXS • PRO2220 	<ul style="list-style-type: none"> • Fusion IV
Centrally Monitored	<ul style="list-style-type: none"> • Small/Medium Commercial • Remote Managed Sites • Web-based Management 	<ul style="list-style-type: none"> • WIN-PAK PRO Central Station 	<ul style="list-style-type: none"> • NetAXS • PRO2200 	<ul style="list-style-type: none"> • Fusion IV

Ordering

Model HF4= Fusion IV DVR

Number of Channels
 8=8 Channels
 16=16 Channels
 32=32 Channels**

Capture Rate (@ CIF resolution)
 NTSC/PAL
 12 = 120ips / 10 = 100ips*
 24 = 240ips / 20 = 200ips*
 48 = 480ips / 40 = 400ips***

Accessories
 A= Factory Installed Accessories
 N= No Accessories

Internal Storage
 500= GB Storage
 1T0= 4 TB Storage
 2T0= 2 TB Storage
 4T0= 4 TB Storage
 8T0= 8 TB Storage

Video Display/Compression
 R=Real Time/MJPEG, MPEG4
 H.264
 H= Real Time/H.264 D1/4CIF

* 100ips available in 16ch only
 ** 32ch available in R series only
 *** 400ips available in 32ch only

- IP Cameras
- Box Cameras
- Dome Cameras
- PTZ Cameras
- IR Cameras
- Housing, Mounts & Lenses
- Special Purpose Cameras
- Recording Solutions
- Management Software & Systems
- System Components

Recording Solutions | PC-BASED

Fusion IV NVR

Because choosing the DVR that best fits your application can be a complicated process, we are committed to helping you make the best choice.



Fusion IV NVR is the perfect choice when:

- Implementing IP based surveillance systems
- Using megapixel cameras
- Integration with embedded intelligent video or data analytics is required
- Seamless integration with WIN-PAK SE, WIN-PAK PE, NetAXS or Pro-Watch access control software platforms is desired

Hardware

- IP recording up to 32 channels
- Available with 8, 16 or 32 video inputs
- Megapixel recording
- Local live viewing
- Internal storage capacity from 500 GB to 12 TB
- External storage options from 1 TB to 48 TB
- Up to 16 audio channels (with supported IP cameras)
- PTZ control on supported IP cameras
- 10/100/1000 Gigabit network standard
- Keyboard control of camera selection and PTZ control
- Windows XP embedded operating system

Access Control Integration of Fusion IV NVR				
	Typical Applications	Software Solution	Hardware Solution	Video Solution
Large Commercial	<ul style="list-style-type: none"> • Medium/Large Commercial • Financial • Pharmaceutical • Universities/Campuses • Government 	<ul style="list-style-type: none"> • Pro-Watch CE with Maxpro VMS • WIN-PAK PE • WIN-PAK SE 	<ul style="list-style-type: none"> • PW-6000 • NetAXS • PRO2220 	<ul style="list-style-type: none"> • Fusion IV NVR
Centrally Monitored	<ul style="list-style-type: none"> • Small/Medium Commercial • Remote Managed Sites • Web-based Management 	<ul style="list-style-type: none"> • WIN-PAK PRO Central Station 	<ul style="list-style-type: none"> • NetAXS • PRO2200 	<ul style="list-style-type: none"> • Fusion IV NVR

Ordering

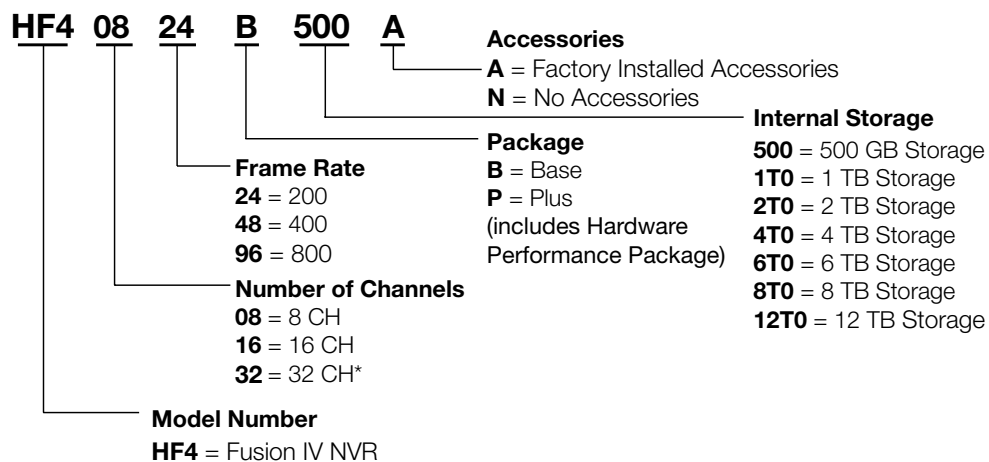

* Performance (P) package a must for 32ch/800 ips and optional for 16, 8ch/800ips
 Note: 200ips for 8ch/400ips for 16, 32ch/800ips for 32ch - only

Recording Solutions | PC-BASED

Fusion IV NVR and DVR - Common Accessories

Factory Installed Accessories	
HF4HWUPGCPU	Fusion IV Hardware Performance Package (Includes Quad Core CPU & 1GB Memory Upgrade)
HF4R5	Fusion IV Internal RAID5 Configuration (Must have 3 drives)
HFDVRGBNIC	Gigabit Network Interface – adds 2nd Ethernet Port to Fusion IV
HFDVR4VOU	4 CH Analogue TV Output Card (for all Fusion IV DVR models)
HF4VOU	4 CH Multiplexed Analogue TV Output Card (for all Fusion IV DVR models)
HFDVR16AUDIO	16 CH Audio Input Card (for all Fusion IV DVR models)
Embedded Intelligent Data Analytics (Factory Installed)	
HAIMDPFKG	IDM EE Licenses to support up to 4 POS terminals
HAIMETADDSW	IDM EE Terminal License for HAIMDPFKG, 1 add-on Terminal license
HAIMDPFKG	IDM ProE Licenses to support 1 POS terminal
HAIMETADDSW	IDM ProE Terminal Licenses for HAIMDPFKG, 1 add-on Terminal license
External Storage Accessories	
HE520RA4	4 BAY Raid 5 - 1RU SCSI U320 Rackmount 500GB SATA II Hard Drives. 2.0 TB Total Capacity
HE540RA4	4 BAY Raid 5 - 1RU SCSI U320 Rackmount 1TB SATA II Hard Drives. 4.0 TB Total Capacity
HE580RA8	8 BAY Raid 5 - 2RU SCSI U320 Rackmount 1TB SATA II Hard Drives. 8.0 TB Total Capacity
HE5120RA12	12 BAY Raid 5 - 2RU SCSI U320 Rackmount 750GB SATA II Hard Drives. 12.0 TB Total Capacity
HE5240RA12	24 BAY Raid 5 - 4RU SCSI U320 Rackmount 1TB SATA II Hard Drives. 24 TB Total Capacity (Only for enterprise solutions)
HE560RA12	12 BAY Raid 5 - 2RU SCSI U320 Rackmount 1TB SATA II Hard Drives. 16.0 TB Total Capacity
ASC39160	SCSI adapter card for controlling Raid 5 U320 systems. To be used with Fusion IV DVRs
HFDVREXT8T	External Storage 8 TB – includes SCSI adapter
HFDVREXR5T	External RAID 5 TB – requires separate SCSI adapter
HFDVREXR8T	External RAID 8 TB – requires separate SCSI adapter
HFDVREXR16T	External RAID 16 TB – requires separate SCSI adapter
Field Installed Accessories	
HF4HWUPGCPUF	Fusion IV Hardware Performance Package (Includes Quad Core CPU & 1GB Memory Upgrade)
HF4RMKT	Rack Mounting Rails (for Fusion IV NVR models only)
HF4HD2T0	Fusion IV 2 TB Upgrade Kit (Includes Fusion IV Drive Tray)
HF4HD1T0	Fusion IV 1 TB Upgrade Kit (Includes Fusion IV Drive Tray)
HF4HD500	Fusion IV 500 GB Upgrade Kit (Includes Fusion IV Drive Tray)
Software Part Numbers	
HFRVS	Fusion Remote View Software
HFVMS	Fusion Video Management Software
HFVMSP	Single Workstation License to access Performance Series HRDP as well as Fusion DVR's
NVR Software Licenses	
HFLICNVR1	1 CH Fusion IP/ Network Video License (Add up to 4 CH of Network Video to Fusion IV Systems)
HFLICNVR4	4 CH Fusion IP/ Network Video License (Add 4 CH of Network Video to Fusion IV Systems)
HFLICNVR8 ²	8 CH Fusion IP/ Network Video License (Add 8 CH of Network Video to Fusion IV Systems)
HFLICNVR16 ²	16 CH Fusion IP/ Network Video License (Add 16 CH of Network Video to Fusion IV Systems)
HFLICDATA	1 CH Fusion 4 Alarm Panel for POS Data License
Other Recommended Accessories	
HJC4000	PTZ camera and DVR controller
² Requires HF4HWUPGCPU.	

We are pleased to announce that Fusion IV software (for DVR and NVR) version 4.50.1505 now supports 32 IP channel operation. This software version also provides improved robustness for IP camera connectivity.

IP Cameras

Box Cameras

Dome Cameras

PTZ Cameras

IR Cameras

Housing, Mounts & Lenses

Special Purpose Cameras

Recording Solutions

Management Software & Systems

System Components

Recording Solutions | PC-BASED

MAXPRO® NVR SE

COMING SOON!

16 AND 32-CHANNEL REAL-TIME NETWORK VIDEO RECORDER (NVR)

Honeywell's MAXPRO® NVR SE is an ideal solution for entry into IP video surveillance systems. Utilizing Honeywell's high definition cameras, MAXPRO NVR SE is a powerful, high definition IP recording system and viewing client for small to medium size installations.

MAXPRO NVR SE comes pre-installed with all required software and is also pre-licensed for 16 or 32 channels. This, along with the discovery tool makes installing high definition IP systems quick and efficient. Simple and logical configuration pages make setup a breeze even for the novice installer.



MAXPRO NVR SE **HD**
without locking faceplate



MAXPRO NVR SE **HD**
with locking faceplate

Ordering	
HNM32N1T	MAXPRO NVR SE 32 Ch, NVR, 3U Rackmount, 1x1TB removable HD, 3x spare HD slots, DVD-RW, GIG Ethernet, Includes 3 year advanced replacement
HNM32N2T	MAXPRO NVR SE 32 Ch, NVR, 3U Rackmount, 2x1TB removable HD, 2x spare HD slots, DVD-RW, GIG Ethernet, Includes 3 year advanced replacement
HNM32N4T	MAXPRO NVR SE 32 Ch, NVR, 3U Rackmount, 2x2TB removable HD, 2x spare HD slots, DVD-RW, GIG Ethernet, Includes 3 year advanced replacement
HNM32N8T	MAXPRO NVR SE 32 Ch, NVR, 3U Rackmount, 4x2TB removable HD, DVD-RW, GIG Ethernet, Includes 3 year advanced replacement
HNM16N1T	MAXPRO NVR SE 16 Ch, NVR, 3U Rackmount, 1x1TB removable HD, 3x spare HD slots, DVD-RW, GIG Ethernet, Includes 3 year advanced replacement
HNM16N2T	MAXPRO NVR SE 16 Ch, NVR, 3U Rackmount, 2x1TB removable HD, 2x spare HD slots, DVD-RW, GIG Ethernet, Includes 3 year advanced replacement
HNM16N4T	MAXPRO NVR SE 16 Ch, NVR, 3U Rackmount, 2x2TB removable HD, 2x spare HD slots, DVD-RW, GIG Ethernet, Includes 3 year advanced replacement
HNM16N8T	MAXPRO NVR SE 16 Ch, NVR, 3U Rackmount, 4x2TB removable HD, DVD-RW, GIG Ethernet, Includes 3 year advanced replacement

Accessories	
HNMHD1T0	1 TB SATA Raid Edition Hard Drive (Drive tray included with unit)
HNMHD2T0	2 TB SATA Raid Edition Hard Drive (Drive tray included with unit)

Refer to the storage calculator on www.honeywellvideo.com to help determine what size unit to order.

NOTE: Honeywell reserves the right, without notification, to make changes in product design or specifications.

Recording Solutions | PC-BASED

Rapid Eye™ Hybrid HD Active Alert® **NEW!**

16-CHANNEL HYBRID HIGH DEFINITION DIGITAL VIDEO RECORDER (DVR) SYSTEM WITH VIDEO ANALYTICS

Rapid Eye Hybrid HD is fully integrated with the Honeywell suite of security products: MAXPRO® VMS, access control and intrusion. From standalone remote systems to fully integrated enterprise solutions, Rapid Eye is effective in a wide range of security installations.

Rapid Eye uses a Linux-based operating system that is extremely secure, stable and reliable. Standard storage capacities range from 500 GB to 1 TB, field expandable up to 3 TB. The Rapid Clip feature makes remote clip generation to a USB device or the internal DVD-RW fast and easy.



Features

The system consists of three major components:

- Digital Video Recorder, featuring DSP-powered hardware capable of capturing video at 4CIF, 2CIF and CIF resolutions at up to 30 IPS (real time) per camera depending on the selected recording resolution.
- ADMIN Software, the workstation/server-based administration tool capable of enterprise-wide site and user management.
- VIEW Software, a feature-rich, workstation-based remote operator program with integrated support for video analytics – Active Alert® Live, Active Alert® Forensics, Active Alert® Reporting and Active Alert® Configuration.

The availability of such a powerful set of tools—ADMIN, VIEW and Active Alert—combined with the DSP-powered DVR truly differentiates Rapid Eye™ Hybrid HD Active Alert® from the competition.

Ordering		HRE	16	A	48	D	1T0	
Model	Honeywell Rapid Eye™							Storage Size
								500 500 GB 1T0 1 TB
# of Channels	16							Media Options
								D DVD-RW
Analytics								Record Rate@ Resolution
								48 NTSC 480 IPS @ CIF 40 PAL 400 IPS @ CIF

NOTE: Honeywell reserves the right, without notification, to make changes in product design or specifications.

- IP Cameras
- Box Cameras
- Dome Cameras
- PTZ Cameras
- IR Cameras
- Housing, Mounts & Lenses
- Special Purpose Cameras
- Recording Solutions
- Management Software & Systems
- System Components

Recording Solutions | PC-BASED

Rapid Eye™ Hybrid HD

NEW!

16-CHANNEL HYBRID HIGH DEFINITION DIGITAL VIDEO RECORDER (DVR) SYSTEM

Rapid Eye Hybrid HD is fully integrated with the Honeywell suite of security products: MAXPRO® VMS, access control and intrusion. From standalone remote systems to fully integrated enterprise solutions, Rapid Eye is effective in a wide range of security installations.

Rapid Eye uses a Linux-based operating system that is extremely secure, stable and reliable. Standard storage capacities range from 500 GB to 1 TB, field expandable up to 4 TB. The Rapid Clip feature makes remote clip generation to a USB device or the internal DVD-RW fast and easy.



HD

Features

Hardware

- Hybrid support for up to a combined total of 16 channels of analog and IP cameras
- IP camera support for up to four EQUIP® v2 and/or HD3 or HD4 IP cameras with local UI turned on, and a maximum of 16 IP channels with local UI turned off
- Real-time recording rates (NTSC/PAL)
- Up to 4CIF analog camera recording and/or viewing resolution
- IP camera maximum recording and viewing resolution is 1280x720 (HD)
- Live viewing using LocalView
- DVD-RW drive for local clip generation
- 16 looping video inputs
- Dual audio channels (Bi-directional and VoIP)
- 16 alarm inputs, 8 control outputs, 8 serial ports

Software

- Analog camera resolutions: selectable independently per camera for live and recording
- IP camera resolutions: selectable per camera, live and recording resolutions are the same
- Event-driven response recording
- TCP/IP port forwarding –multiple units share an IP address
- DHCP (requires DHCP Server and WINS/DNS services)
- SNTP client automatically synchronizes to SNTP servers
- RapidSearch™ for video evidence by events, data, motion or alarm
- IntelliBus™ protocol support

Ordering

		HRE	16	R	48	D	1T0
Model	Honeywell Rapid Eye™					Storage	Size
						500	500 GB
						1T0	1 TB
# of Channels	16					Media Options	
						D	DVD-RW
						N	No DVD-RW
Feature						Record Rate @ Resolution	
R	Real-time					48	NTSC 480 IPS @ CIF
A	Analytics + Real-time					40	PAL 400 IPS @ CIF
	Note: only 480/400 IPS available on Analytics units					12	NTSC 120 IPS @ CIF
						10	PAL 100 IPS @ CIF

NOTE: The resolutions listed above refer to recording rates for analog camera systems only.

Recording Solutions | PC-BASED

Rapid Eye™ LT v9 NEW! 4 AND 8 CHANNEL, 120/100 IPS DIGITAL VIDEO RECORDER (DVR) SYSTEM

Rapid Eye can record, search and transmit video, audio and data transactions while simultaneously providing users with both live monitoring and post-event playback operation.

Rapid Eye LT is fully integrated with the Honeywell suite of security products: MAXPRO® VMS, access control and intrusion. From standalone remote systems to fully integrated enterprise solutions, Rapid Eye is effective in a wide range of security installations.

Rapid Eye uses a Linux-based operating system that is extremely secure, stable and reliable. Standard storage capacities range from 500 GB to 1 TB.

Features

Hardware

- 4 or 8 looping video inputs
- Real-time recording rates at CIF resolution: 120/100 global (NTSC/PAL)
- Up to 4CIF recording and/or viewing resolution
- Storage capacity of 500 GB or 1 TB
- Optional DVD-RW drive for clip generation and easy software upgrades
- Dual audio channels (Bi-directional and VoIP)
- Public Display Mode
 - Multiplexed using composite video output
 - Switching using spot monitor output
- 4 or 8 alarm inputs, 4 control outputs

Software

- Resolutions: selectable per camera
 - Independently for live display and recording
- Event-driven response recording
- Enhanced PTZ control and configuration
- Expanded POS capability for up to four devices
- Hierarchical site tree – group by region, location, etc.
- Network Address Translation (NAT)
 - TCP/IP port forwarding
 - Multiple units share an IP address
- DHCP (requires DHCP server and WINS/DNS services)
- SNTP client automatically synchronizes to SNTP servers
- RapidSearch™ for video evidence by events, data, motion or alarm
- IntelliBus™ protocol support



Ordering

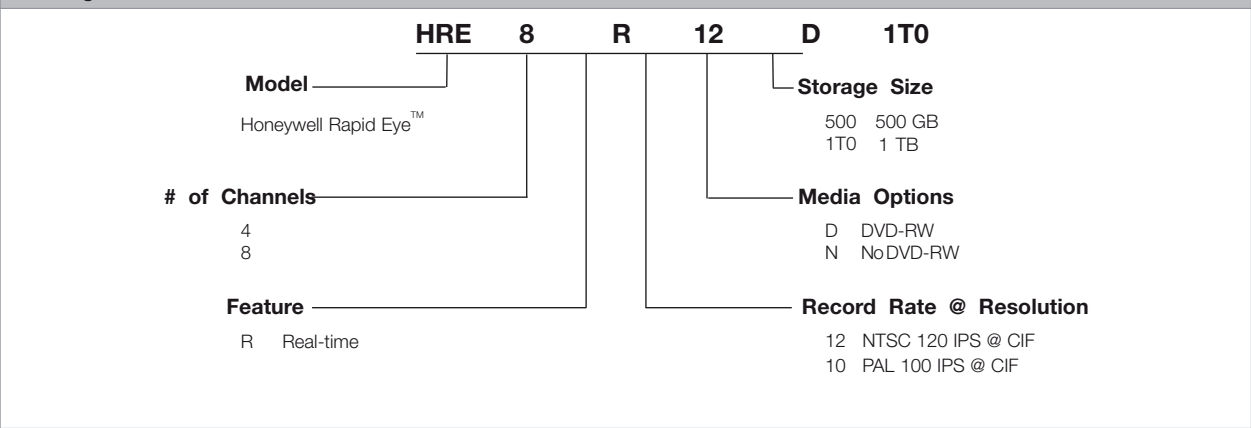

NOTE: Honeywell reserves the right, without notification, to make changes in product design or specifications.

- IP Cameras
- Box Cameras
- Dome Cameras
- PTZ Cameras
- IR Cameras
- Housing, Mounts & Lenses
- Special Purpose Cameras
- Recording Solutions
- Management Software & Systems
- System Components

Recording Solutions | PC-BASED

Common Accessories for Rapid Eye™

Ordering

Software for Rapid Eye Hybrid HD / Active Alert	
HRM10ADMIN (included)	ADMIN & VIEW software CD & user manuals
HRM10VIEW	VIEW software CD & user manuals
HRM10CLIP	Clip player for Windows
HRM10UPADMIN	Upgrade ADMIN & VIEW Software CD and User Manuals
Software for Rapid Eye LT v9	
HRM9ADMIN	ADMIN & VIEW software CD and user manuals
HRM9VIEW	VIEW software CD & user manuals
HRM9CLIP	Rapid Eye Clip Player for Windows software CD
HRM9UPADMIN	Upgrade ADMIN & VIEW software CD and user manuals
Recommended Accessories	
HVBPIT44-US	RS422 dome protocol interface translator, Bossware
HVBPIT4POS	Four to one serial protocol interface translator, POS or alarm panel data
HASMPIT	SmartPIT™, POS/ECR or ATM text inserter and PTZ protocol translator, compatible with NTSC or PAL video formats
HCSP1	Surge protector, video/24 VAC
HDSP1	Surge protector, data/video/24 VAC
HDCD8TP	Code distribution unit 8 port twisted pair RS232 to RS485
HRPSARE2EARS	Rackmount ears
HRMSLIDE	Rackmount slide kit
HRPSLOCK	Lock for front lid
AAC232/485	Code converter RS232 to RS485
HJC5000	PTZ Controller / UltraKey Lite Keyboard
Analog Cameras (Fixed Cameras, Domes, PTZ)	See Honeywell's full line of indoor and outdoor cameras, housings, and lenses
ACUIX™ IP	Honeywell PTZ network camera series
EQUIP® v2 Series Network Cameras	HD4DIP, HD4DIPX, HCD554IP, HCD554IPX, HD4MDIP, HD4MDIPX, HD3MDIP, and HD3MDIPX

Expansion Hard Drives and Spare Hard Drives	
<i>Hard drive only (blank) in frame for 16 ch Rapid Eye Hybrid HD v9/v10 units (with or without Analytics). Not usable/interchangeable with Rapid Eye v8 or older legacy units.</i>	
HREHD500G	Hard drive expansion Rapid Eye Hybrid HD v10, SATA, 500 GB, in frame
HREHD1T0	Hard drive expansion Rapid Eye Hybrid HD v10, SATA, 1 TB, in frame
<i>Hard drive only (blank) without frame for 16 ch Rapid Eye Hybrid HD v9/v10 units (with or without Analytics). Not usable/interchangeable with Rapid Eye v8 or older legacy units.</i>	
HREHD500G-N	Hard drive only, 3.5" Rapid Eye Hybrid HD v10, SATA, 500 GB, no frame
HREHD1T0-N	Hard drive only, 3.5" Rapid Eye Hybrid HD v10, SATA, 1 TB, no frame
<i>Hard drive (system pre-installed) in frame for Rapid Eye Hybrid HD v9/v10 units, WITHOUT Analytics ONLY! Not usable / interchangeable with Rapid Eye v8 or older legacy units.</i>	
HREHD500GP10	Hard drive v10 program Rapid Eye Hybrid HD v10, without Analytics, SATA, 500 GB, in frame
HREHD1T0P10	Hard drive v10 program Rapid Eye Hybrid HD v10, without Analytics, SATA, 1 TB, in frame
<i>Hard drive (system pre-installed) without frame for Rapid Eye Hybrid HD v9/v10 units, WITH Analytics ONLY! Not usable/interchangeable with Rapid Eye Hybrid HD units without Analytics or older legacy units.</i>	
HREHD500GA10	Hard drive program for Rapid Eye Hybrid HD v10, with Analytics, 500 GB, in frame

NOTE: Honeywell reserves the right, without notification, to make changes in product design or specifications.

Recording Solutions | EMBEDDED

HRDPX16 DVR

480/400 (NTSC/PAL) IPS 16-CHANNEL EMBEDDED DIGITAL VIDEO RECORDER

HRDPX16 supports continuous, event, and combined continuous/event recording and is configurable per channel. Upon detection of motion, HRDPX can automatically boost the ips recording rate to capture additional details of the scene. In addition to recording at a rate of up to 480/400 ips NTSC/PAL, HRDPX16 supports high-end capabilities such as user-friendly front panel control, mouse operation, IR remote control, a Setup Wizard for fast and easy DVR setup, Express Search to quickly find the evidence video, an internal DVD-RW and two USB ports for copying evidence video to portable media.



Features

- 16 looping video inputs
- 16 audio inputs, 1 audio output
- Continuous recording during playback and during transmitting to remote site
- Mouse control via front panel
- Built-in DVD-RW drive and two USB 2.0 ports
- Records up to 480/400 images per second NTSC/PAL
- PTZ dome control for a wide variety of protocols
- Remote access through web browser and/or Remote Software, LAN/WAN (internal NIC), and DSL (remote access software included)
- Self-diagnostics with automatic notification including hard disk drive S.M.A.R.T. protocol
- Infrared remote control included
- Embedded Linux OS — OS embedded in flash

Ordering

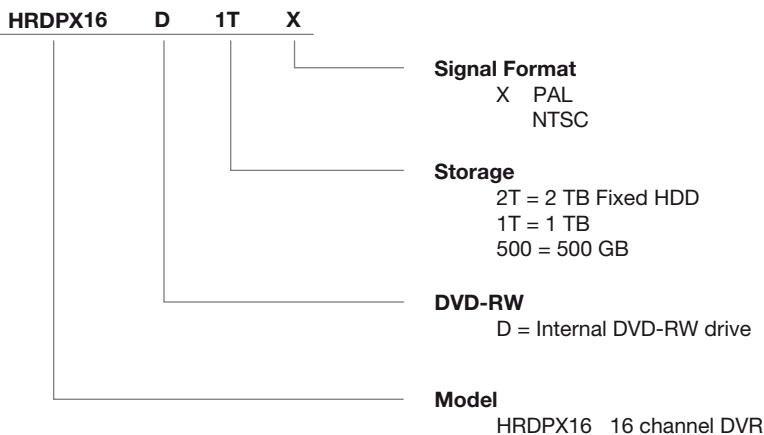

RELEASING SOON!

HRDPX16 DVR H.264 version

- IP Cameras
- Box Cameras
- Dome Cameras
- PTZ Cameras
- IR Cameras
- Housing, Mounts & Lenses
- Special Purpose Cameras
- Recording Solutions
- Management Software & Systems
- System Components

Recording Solutions | EMBEDDED

HRDP H.264 DVR Series

NEW!

240ips/200ips - 16, 8 & 4 CHANNEL - EMBEDDED DIGITAL VIDEO RECORDER

The HRDP H.264 digital video recorder (DVR) offers clear crisp video using H.264 video compression and a high image per second recording rate. HRDP supports a feature set comparable to many high-end embedded DVRs but at a much lower price!



Features

- 4, 8 or 16 looping video inputs
- 4 audio inputs, 1 audio output
- Continuous recording during playback and transmitting to remote site
- Mouse (not included) control via front panel
- Built-in DVD-RW and two USB 2.0 ports
- Records up to 240/200 images per second NTSC/PAL
- PTZ dome control for a wide variety of protocols
- Remote access through web browser and/or Remote Software, LAN/WAN (internal NIC), and DSL (remote access software included)
- Self-diagnostics with automatic notification including hard disk drive S.M.A.R.T. protocol
- Infrared remote control included
- Embedded Linux OS — OS embedded in flash

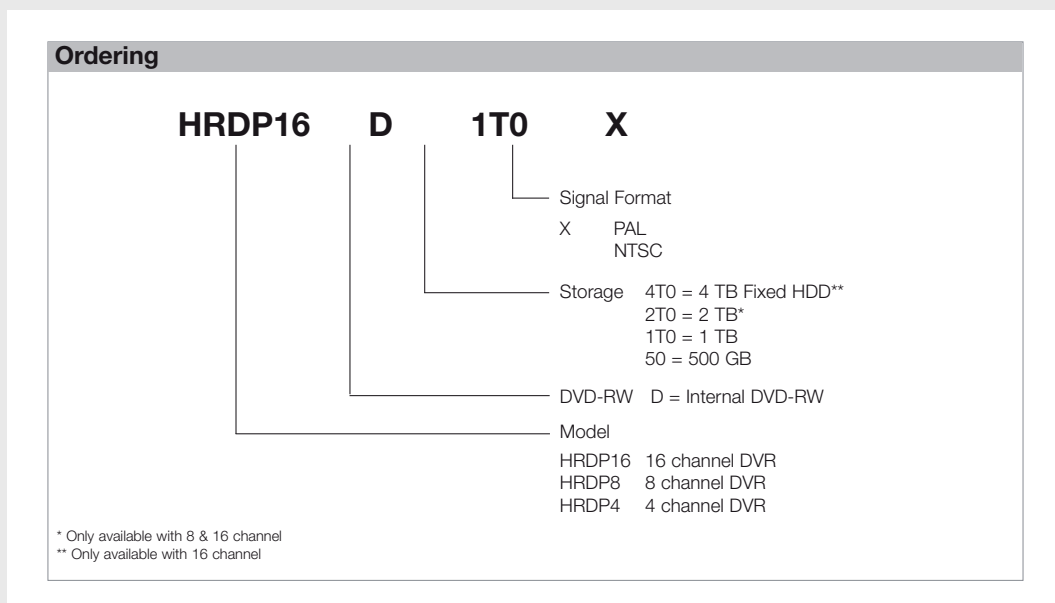

Recording Solutions | EMBEDDED

HREP DVR - Performance Series

NEW!

240ips/200ips 16 & 8 CHANNEL, 120ips/100ips 4 CHANNEL - EMBEDDED DIGITAL VIDEO RECORDER

The HREP digital video recorder (DVR) offers clear crisp video using H.264 video compression and supports a high-end feature set that exceeds the needs of many surveillance applications at a very economical price.



Recording at a rate of up to 240 ips, the HREP DVR supports a wide variety of capabilities such as mouse operation, IR remote control, and multiple search engines to quickly find video evidence. Video evidence files can be loaded onto CD, DVD, or USB media easily with an internal DVD burner* and 2 USB ports.

Features

- 4, 8 or 16 video inputs
- 4 audio inputs, 1 audio output
- Continuous recording during playback and during transmitting to remote site
- Mouse (not included) control via front panel
- Built-in DVD burner* and 2 USB 2.0 ports
- Recording rates of up to 200 images per second
- PTZ dome control for a wide variety of protocols
- Remote access through web browser, LAN/WAN (internal NIC) and DSL
- Self-diagnostics including hard disk drive S.M.A.R.T. monitoring
- Infrared Remote Control included
- Embedded Linux OS — OS embedded in flash

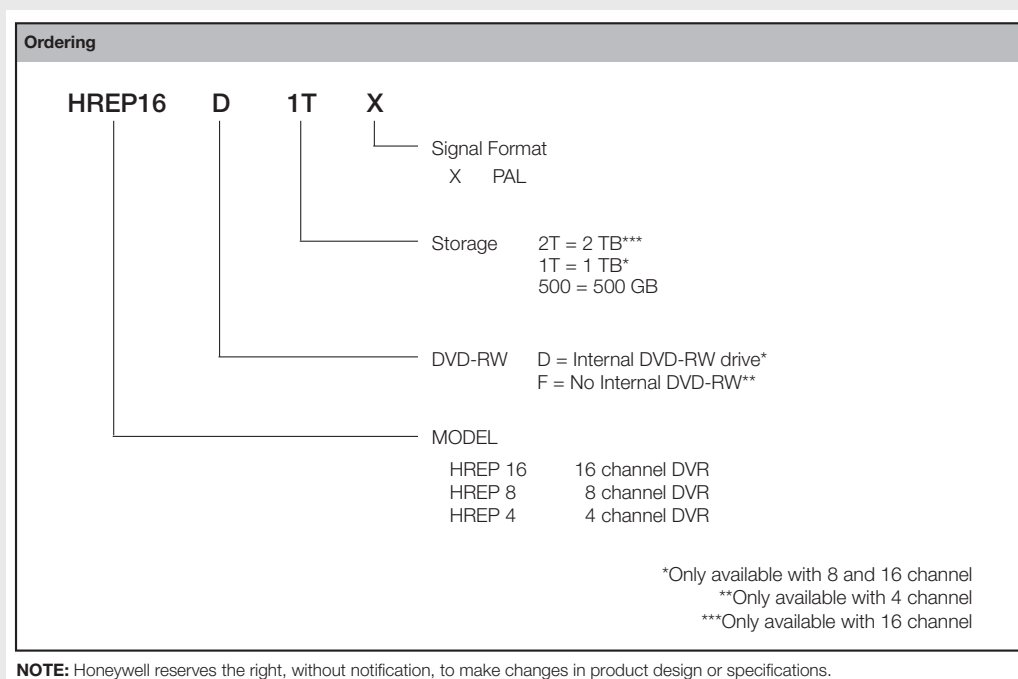

NOTE: Honeywell reserves the right, without notification, to make changes in product design or specifications.

IP Cameras

Box Cameras

Dome Cameras

PTZ Cameras

IR Cameras

Housing, Mounts & Lenses

Special Purpose Cameras

Recording Solutions

Management Software & Systems

System Components

Recording Solutions | EMBEDDED

HRXDS Series

8 AND 16 CHANNEL EMBEDDED DVR

NEW!

The HRXDS Series DVR is a high-performance recording system that combines the benefits of digital recording up to 240/200 ips (NTSC/PAL) with the advanced processing of a multiplexer. HRXDS features Honeywell's sophisticated, proprietary XtraStor compression technology that provides more storage on smaller media without sacrificing image quality – resulting in days, weeks and even months of high-resolution video storage.



Features

- 8 or 16 looping video inputs (model dependent)
- Long-term video storage using XtraStor technology
- Records up to 240/200 images per second (NTSC/PAL)
- Built-in DVD-RW drive and 3 USB 2.0 ports
- Infrared remote control
- Mouse (not included) interface via USB port
- Text input for interface to automatic teller machines (ATM) and point of sale (POS) terminals
- Disk mirroring and video archiving
- PTZ dome control for a wide variety of protocols
- Web browser access via PC with Microsoft Internet Explorer
- Remote access through PSTN, LAN/WAN (internal NIC), DSL and ISDN (remote access software included)
- Ultra-wide SCSI port connects to an external storage device
- Multiple monitor connectors: 1 BNC Video Out, 1 SVHS, 4 Spot, 1 VGA
- 4-channel audio recording and 1-channel audio playback

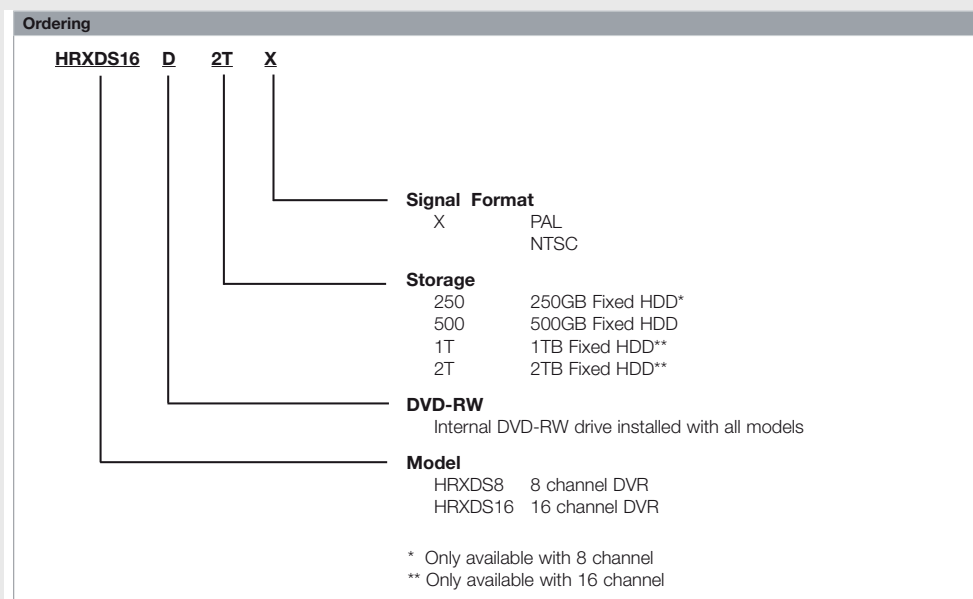



Management Software and Systems Solutions

The Honeywell IP security surveillance portfolio allows integration of a broader range of technology – including video analytics, megapixel cameras and a new video management platform – into existing analog systems. By integrating the latest in digital and IP technology with traditional analog components, end users can better control operational costs and maximize existing investments in surveillance equipment.

THIS SECTION INCLUDES:

- MaxPro VMS
- IP Encoder
- Matrix Switching Systems
- Intelligent Video and Data Analytics

- IP Cameras
- Box Cameras
- Dome Cameras
- PTZ Cameras
- IR Cameras
- Housing, Mounts & Lenses
- Special Purpose Cameras
- Recording Solutions
- Management Software & System Solutions
- System Components

Management Software and Systems Solutions

IP SYSTEMS

IP SYSTEMS

The Honeywell IP security surveillance portfolio allows integration of a broader range of technology – including video analytics, megapixel cameras and a new video management platform – into existing analog systems. By integrating the latest in digital and IP technology with traditional analog components, end users can better control operational costs and maximize existing investments in surveillance equipment.

Honeywell IP Systems at a Glance

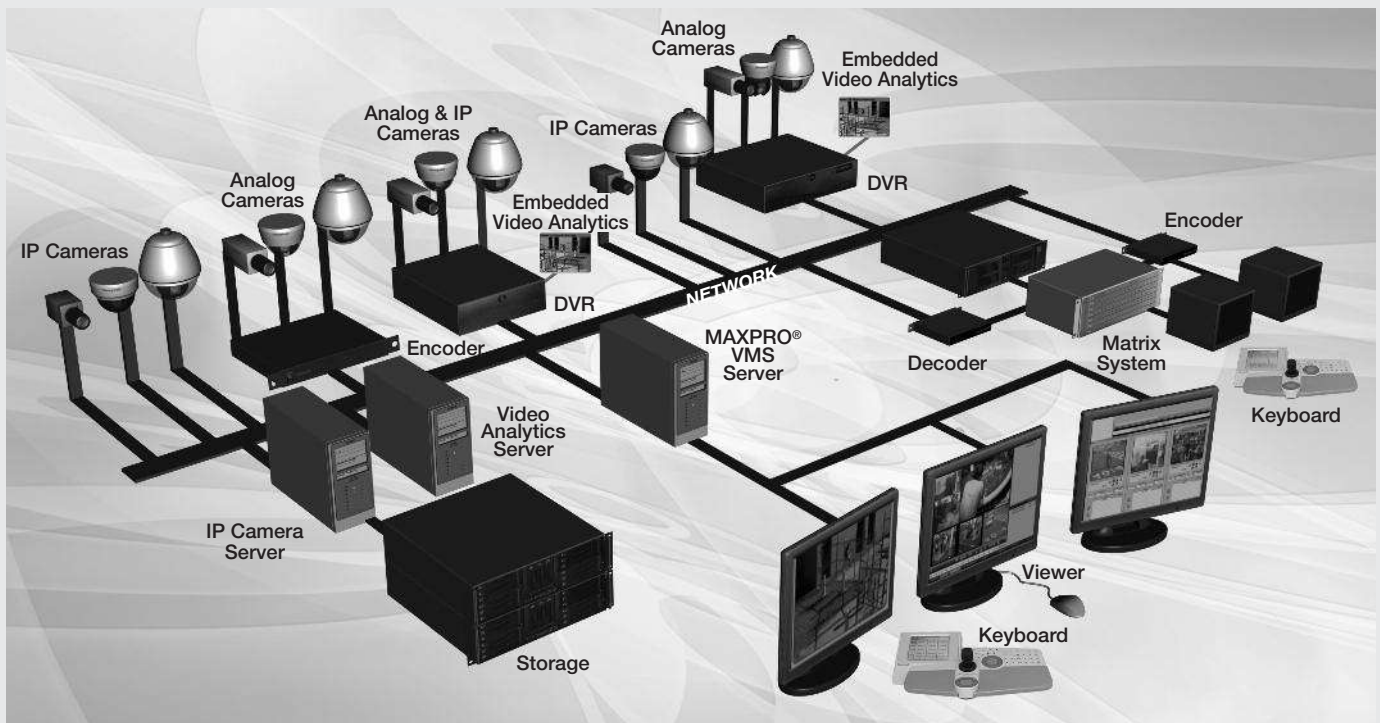

Honeywell's IP portfolio includes our MAXPRO® VMS video management system, EQUIP® Series IP cameras, and our new HCX Series of megapixel cameras.

MAXPRO VMS	EQUIP Series IP Cameras	HCX Series Megapixel Cameras
An intelligent video management system that controls digital and analog video infrastructures and third-party components to manage and present video in a clear and concise manner. MAXPRO VMS integrates with Honeywell's Pro-Watch® security management platform to provide complete control of alarm/event actions from Pro-Watch.	Provides extremely high-picture quality (up to 4CIF), efficiency (MPEG-4), and real-time video (30 fps) NTSC / (25 fps) PAL. The line includes two box cameras, a vandal resistant mini-dome, and the ACUIX™ IP PTZs. EQUIP Series features an externally accessible web-based menu and camera tamper detection that lets users know instantly if a camera has been blinded or vandalized.	Provides network surveillance for high-resolution object recognition beyond standard analog camera capabilities. IP connectivity lets users view and control cameras from virtually anywhere, and analog video output lets users quickly customize the camera setup and easily send snapshots or video clips to e-mail or FTP addresses.

Management Software and Systems Solutions

VIDEO MANAGEMENT

MAXPRO® VMS

Honeywell's MAXPRO® VMS (Video Management System) controls multiple sources of video subsystems to enhance the user's video surveillance experience with maximum efficiency and minimum effort. Using an open architecture and IP-based systems, MAXPRO VMS leverages an existing video infrastructure to collect, manage and present video in a clear and concise manner.



MAXPRO® VMS IP-based System Architecture

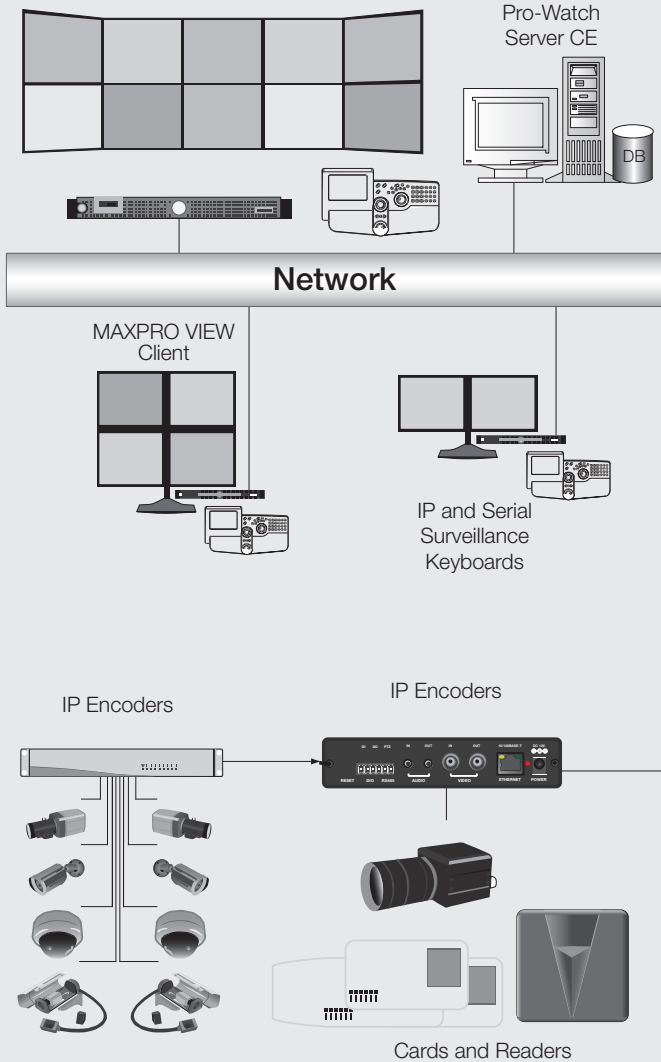

MAXPRO VMS is based on client-server architecture for maximum flexibility, customization and integration. The client-server enables the monitoring of sites and the configuration of video devices such as cameras, monitors, keyboards, etc. It is also flexible enough to accommodate a framework controller and database, and other core components.

MAXPRO VMS seamlessly integrates with analog and digital video devices from Honeywell and other third parties:

Digital Devices

- IP NVR
- Rapid Eye™ DVR
- Fusion DVR
- Fusion NVR

Analog Devices

- MAXPRO-Net switchers
- VideoBloX switchers

IP Cameras

Box Cameras

Dome Cameras

PTZ Cameras

IR Cameras

Housing, Mounts & Lenses

Special Purpose Cameras

Recording Solutions

Management Software & System Solutions

System Components

Management Software and Systems Solutions

VIDEO MANAGEMENT

MAXPRO® VMS Single Command and Control Interface

Honeywell's MAXPRO VMS solution offers a single command and control interface to efficiently operate various products from an expansive list of video equipment including Honeywell and other third parties. MAXPRO VMS intelligently determines the capabilities of each subsystem across various sites, allowing management of any analog or digital

video device through a unified configuration and viewer. The subsystems can be any combination of analog switchers such as MAXPRO-Net and VideoBloX connected to analog monitors and cameras, with concurrent connections to digital devices that are managed using virtual switchers, multiplexers and monitors.



Integrated Video and Security Management System MAXPRO VMS and Pro-Watch®

The integration of MAXPRO VMS and Pro-Watch affords superior access control with alarm monitoring and video capabilities. For example, a Pro-Watch operator can control the access of a cardholder by simply using video verification from the MAXPRO VIEW interface. Whether they're using Pro-Watch Enterprise, Corporate for Professional editions, we can integrate MAXPRO VMS with your customer's security management system – giving them maximum physical security protection.



Next Generation Vision MAXPRO VIEW Client Software

MAXPRO VIEW is the feature-rich next generation viewer that works with MAXPRO VMS to help operators intuitively perform video operations, thereby increasing personal productivity and responsiveness. MAXPRO VIEW provides a uniform look and feel for controlling any type of video device. The dynamic graphical user interface automatically determines the capabilities of every video device integrated to MAXPRO VMS and generates immediate options for performing actions such as receiving and acting on alarms, receiving device status, and performing pan/tilt/zoom operation.

Management Software and Systems Solutions

IP ENGINE (WITH MAXPRO VMS CLIENT)

IP Cameras
Box Cameras
Dome Cameras
PTZ Cameras
IR Cameras
Housing, Mounts & Lenses

IP ENGINE

Honeywell's DVM is a distributed IP-based open architecture video management system leveraging standard IP networks. It is a standalone system that is also integrated into Honeywell's Pro-Watch access control software as well as other third party systems.

- Uses commercial off-the-shelf (COTS) Intel and Windows® based PC systems for scalability
- Microsoft SQL server – uses standard database software to enable tracking of all video clips, system events and settings
- Intelligent recording – allows for scheduled, event, operator initiated, and motion detection triggered recording
- Scalability – enables one to thousands of cameras
- Supports a wide range of IP cameras and digital encoders

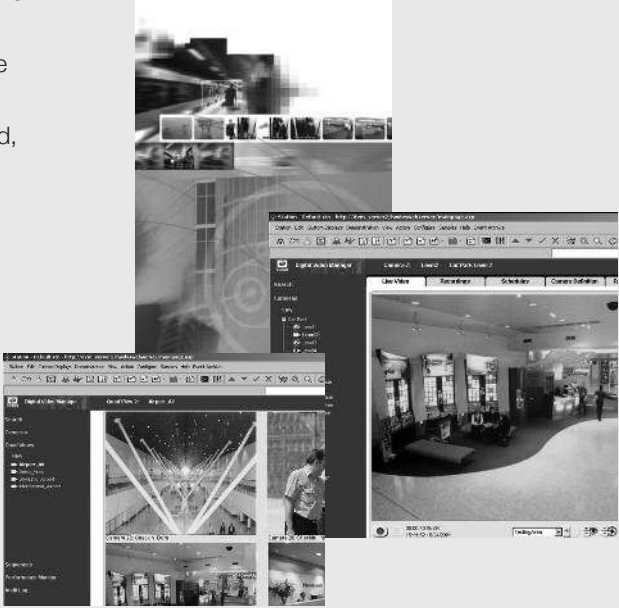

ENCODER

SINGLE CHANNEL NETWORK VIDEO ENCODER

Honeywell's Network Video Encoder (HNVE1) is the ideal real-time, high resolution digital encoder using MPEG-4 up to full D1 resolution for upgrading existing analog video systems to a networked IP video solution. This is an integral component to Honeywell's DVM (Digital Video Manager).

- Supports NTSC or PAL video sources
- Real-time encoding 30/25 fps (NTSC/PAL) at 4CIF or D1 resolution
- Supports MJPEG
- PTZ camera control
- 2-way audio
- One alarm input; one alarm output
- Analog video loopback
- Built-in web server for configuration
- Supports static IP and DHCP



Special Purpose Cameras
Recording Solutions
Management Software & System Solutions
System Components

Part #	Description
HNVE1	1-CH VIDEO STREAMER,BNC

Management Software and Systems Solutions

MATRIX SWITCHING SYSTEMS

MATRIX SWITCHING SYSTEMS

Matrix switchers are video managing devices that can allow full crosspoint switching of sources such as cameras and decoded digital video streams for display on video monitors. Switchers allow for control of PTZ cameras from multiple manufacturers through a single system, and also enable customizable alarm and device control scenarios by simple relay or complex serial interfaces. Matrix switchers help integrate other security solutions such as access control and fire and building controls. They can be used in large and small applications where numerous cameras, PTZ domes, monitors, DVRs and their video peripherals are managed – whether the system is local or distributed over a wide area and networked by multiple users.

Honeywell is a global leader in matrix switch development and offers two established system controllers: the MAXPRO-Net enterprise class-based system controller and the VideoBloX embedded CPU controller. Both system controllers utilize the high density Honeywell Matrix platform for switching and control hardware.



MAXPRO-Net Enterprise Level Matrix Switching

The MAXPRO-Net system is an enterprise level matrix switching system that is an intelligent, highly expandable, CCTV management system.

With unparalleled flexibility and reliability, MAXPRO-Net is well suited for analog matrix environments that require interfacing with existing and future digital NVRs and the flexibility of an extremely powerful macro language.

- Up to 16,000 inputs and 999 outputs on a single node, up to 999 nodes
- Honeywell's UltraKey support over Ethernet and RS232
- Remote diagnostic monitoring over Ethernet
- Remote control to satellite matrix switchers-Ethernet or RS232
- 9999 alarm inputs and outputs
- Control for PTZ cameras from Honeywell and most other major manufacturers
- Powerful macro language allows for complete flexibility in customizing system response to events and custom integration
- High-level interface for integration with third party switchers, digital recording equipment, access control, and alarm management systems
- Modular system allows easy system expansion to protect initial investment
- MAXPRO-Net CPU controls both Legacy MAX-1000 and the ultra compact VideoBloX switching and control hardware
- Full CPU redundancy is available using the MegaPIT auto changeover and port expander unit
- MAXPRO-Net graphics platform (MGP Net) available for control from a PC through mapping and icons



Management Software and Systems Solutions

MATRIX SWITCHING SYSTEMS

VideoBloX Net CPU and 16 Channel Titled Output

The VideoBloX Net CPU is a fully featured, solid state matrix combination controller for the VideoBloX switching and control hardware and a 16 channel titled output card. VideoBloX fits applications where a robust embedded controller is required.

- Create systems as large as 1,248 video inputs and 512 outputs with a single CPU
- Up to 15 network nodes can be configured allowing for remote control of remote nodes using RS422 and Ethernet
- Up to 32 keyboards UltraKey Lite and 6000/1000 alarm inputs or outputs
- Compatible with PTZ domes, DVRs and multiplexers from Honeywell and most other major manufacturers through either PIT or GPIO
- Configured by a simple Windows-based Configurator Application (VideoNETCFG)
- Powerful yet easy to use, 2048x255 step sequence engine for building custom actions to system and external events
- Graphical User Interface control (VideoGUI) available for map based system control
- Device Manager application allows for quick integration to serial controlled devices such as DVRs

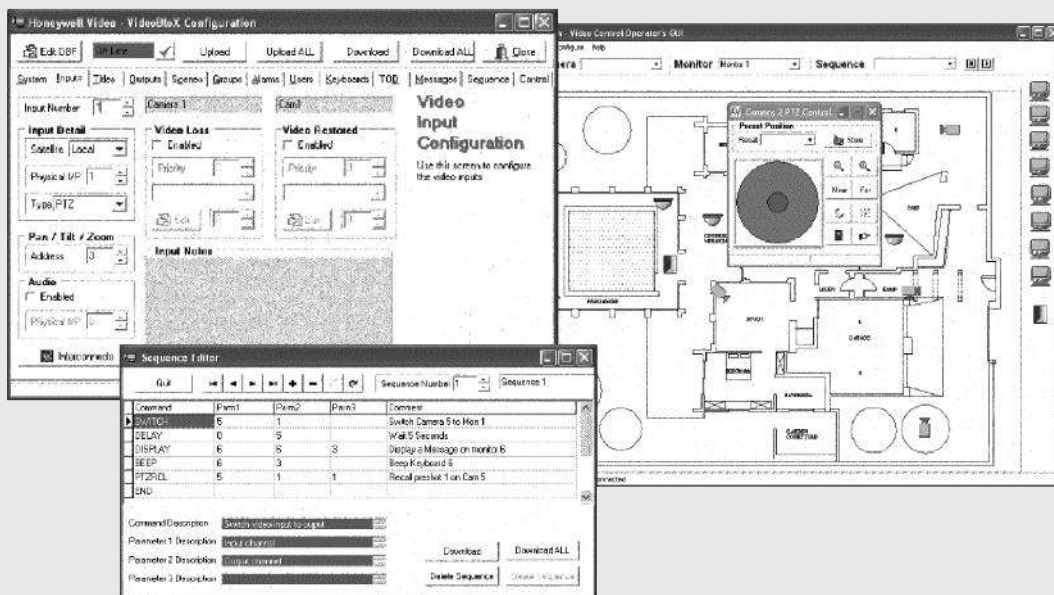

IP Cameras

Box Cameras

Dome Cameras

PTZ Cameras

IR Cameras

Housing, Mounts & Lenses

Special Purpose Cameras

Recording Solutions

Management Software & System Solutions

System Components

Management Software and Systems Solutions

VIDEO AND DATA ANALYTICS

INTELLIGENT VIDEO ANALYTICS

Software Packages:

Active Alert®

Analyzes behavior of individuals and vehicles to provide real-time alarms. Powerful search tools enhance manned and unmanned video surveillance systems.

Smart Impressions®

Detects, counts and reports on human and vehicle traffic patterns. Data mining and trending provides measurable data for operational planning and business optimization.

People Counter

Accurately automates the gathering of data relating to people entering and exiting a specific area or entrance providing valuable operational data for business optimization.

Applications:



Perimeter Protection



Restricted Area



Loitering



Customer Behavior

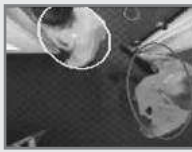

People Counting

Deployment Options



Rapid Eye Active Alert
8 Channels
Embedded Analytics



Fusion IV
2 Channels
Embedded Analytics



Server with Frame
Grabber
16 Channels of Analytics

Benefits:

- Increase productivity – By alerting only suspicious behavior, a single operator is able to monitor a larger area
- Improve security – Automating the continuous surveillance process significantly reduces missed detections
- Control costs – Only activities of interest are alerted, virtually eliminating false alarms
- Improve efficiency – Search tools enable easy incident retrieval in seconds
- Improve operations – Powerful forensic tools enable instantaneous retrieval of incidents

INTELLIGENT DATA ANALYTICS

Honeywell's IDM (Integrated Data Manager) software associates video with business operations data to pinpoint suspicious activity and provide information for improving overall business operations. IDM is ideal for retail, banking and gaming applications.



Benefits:

- Increase profitability – Reduce shrink, address under rings, voids, sweethearting (collusion) and other fraudulent activity
- Improve inventory management – Reduced shrinkage and employee errors results in greater inventory accuracy
- Enhance security management – Enterprise and remote access facilitates centralized management of multiple departments, stores and regions
- Increase management effectiveness and staff productivity – Reduce errors by eliminating manual analysis and identify trends, exceptions and training requirements

Management Software and Systems Solutions

VIDEO ANALYTICS

ACTIVE ALERT®

Honeywell's Active Alert software analyzes the behavior of individuals and vehicles to provide real-time alarms and search tools that enhance manned and unmanned video surveillance systems.

Features:

- Reports 35+ actionable events and behaviors
- Tracks up to 20 targets in each camera view
- Enables user-defined event and alarm settings for each camera view



SMART IMPRESSIONS®

Honeywell's Smart Impressions® video analytics software provides the data that tracks the movement of people and vehicles to help end users better understand their operations.

It provides real-time counting data of people and vehicles entering or exiting a camera scene. Two innovative analytics algorithms include the ability to track people entering a target zone and how long they dwell in the area. This data can provide businesses with powerful insight into the design, use, and efficiency of operations.



PEOPLE COUNTER

People Counter provides the data that enables end users to better understand their operations and maximise potential revenue opportunities. By counting and reporting the number of people entering and exiting a specific area, managers can better understand their closing ratio and identify opportunities for improvement.

CENTRALISED ALARM MANAGEMENT SERVER FOR VIDEO ANALYTICS

Honeywell's Alarm Management suite allows security operators to monitor real-time alarms from a large number of video analytics servers. The Alarm Management Server (AMS) is a service that connects to a large number of Honeywell video analytics servers to receive analytics alarms generated by these servers. Multiple security operators on separate workstations can run separate copies of Alarm Watch Station (AWS) client applications to connect to AMS and collaboratively manage real-time alarms coming from all various analytics servers.

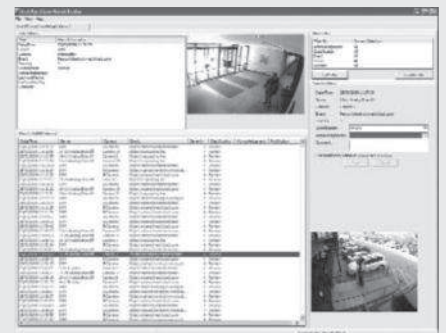

IP Cameras

Box Cameras

Dome Cameras

PTZ Cameras

IR Cameras

Housing, Mounts & Lenses

Special Purpose Cameras

Recording Solutions

Management Software & System Solutions

System Components



Systems Components and Accessories

THIS SECTION INCLUDES:

- Keyboards and Controllers
- LCD Monitors
- Surge Protectors
- Power Supplies

Systems Components and Accessories

KEYBOARDS AND CONTROLLERS

KEYBOARDS AND CONTROLLERS

Keyboards are a critical component of the matrix switching system, enabling better control, ease-of-use, and access to all the functionality of the matrix switch systems.

CCTV peripheral control is managed by intelligent keyboard controllers that interface directly to PTZ domes, DVRs or multiplexers.



UltraKey Plus HJK7000

- Programmable color touch screen display
- Keyboard with multiple connectivity options (RS232/422/485 and TCP/IP)
- Programmable "Touch Wheel" for DVR/NVR control
- Web browser for easy upgrading and configuring
- MAXPRO-Net and VideoBloX compatible



UltraKey Lite® HJC5000

- Keyboard with multiple connectivity options (RS232/422/485 and TCP/IP)
- Web browser for easy upgrading and configuring
- MAXPRO-Net and VideoBloX compatible

IP Cameras

Box Cameras

Dome Cameras

PTZ Cameras

IR Cameras

Lenses

Special Purpose
Cameras

Recording Solutions

Management
Software & SystemsSystem
Components

Systems Components and Accessories

KEYBOARDS AND CONTROLLERS



HKJMMTP

- The keyboard solution for the MAXCOM mini Matrix systems, with 16 camera inputs and 2 monitor outputs
- Ease-of-use and comprehensive dome control
- Twisted pair and coaxial telemetry control through the MAXCOM matrix



HJC4000 Ultrakey Touch

- Direct network connection
- no additional peripherals
- Integration with PTZ & DVRs (Fusion, HRXDS, HRSD)



HTX-5000

- Keyboard to Control :- ScanDome™ III- HZC-855 Series, HZC-755 Series, HZC-655 Series, HCC-745 Series
- Full PTZ control, including Variable speed, for up to 64 ScanDome™ III
- Maximum 7 slave controller
- Preset, Pattern, Scan and Tour function
- Programmable user preferences (alarm, preset, title, etc.)
- Full programming of ScanDome™ III
- Support two levels of password
- Keyboard Lock / Unlock

Systems Components and Accessories

LCD MONITORS AND CODE DISTRIBUTION

LCD MONITORS

Honeywell's LCD monitors are uniquely designed to provide crisp images through advanced functionality, a large viewing area and high resolution. The L-Series monitors feature high grade LCD panels with high brightness, high contrast and fast response times that are designed specifically for the video security and surveillance industry.

LCD MONITORS



HMLCD19L (NTSC) | HMLCD19LX (PAL)
LCD Mon, 19"L-Series, SXGA, BNC & RCA inputs



HMLCD17L (NTSC) | HMLCD17LX (PAL)
LCD Mon, 17"L-Series, SXGA, BNC & RCA inputs

CODE DISTRIBUTION UNIT



HDCD8TP (NTSC) | HDCD8TPX (PAL)
Code Distribution Unit, RS-485, 2 In and 8 Out TP, can also convert RS-232 to RS-485 and act as a code merger to control the same dome(s) from a RS-232 and RS-485 source. North America

- 8-way RS485/RS232 to RS485 bi-directional distribution box
- Front panel LEDs indicate data transmitted to and from the receivers
- Daisy-chain multiple HDCD8TP units provide additional outputs for each receiver

- IP Cameras
- Box Cameras
- Dome Cameras
- PTZ Cameras
- IR Cameras
- Lenses
- Special Purpose Cameras
- Recording Solutions
- Management Software & Systems
- System Components

Systems Components and Accessories

SURGE PROTECTORS

SURGE PROTECTORS

Honeywell's lightweight and low profile surge protectors provide superior protection against voltage spikes that can disable and permanently damage video equipment, resulting in loss of important data.

Honeywell's surge protectors are highly reliable for power and video and have several key features:

- Single point grounding
- BNC female in/out for video protection
- Terminal strip connections for power and data protection



HDSP1

- Dependable protection for any PTZ camera system
- Data protection for video, power and data



HCSP1

- Dependable protection for any fixed camera system including box cameras, bullet cameras, specialty cameras and mini-domes
- Data protection for video and power

Surge Protectors		
	HDSP1	HCSP1
Video Protection		
Service Voltage	2 Vp-p @ 75 Ohms	
Clamping Voltage	2.8 VDC	
	<1.0 dB @ 0-2.0 GHz	
Peak Pulse Current	20K A	
Voltage Protection		
Service Voltage	24 VAC/VDC	
Clamping Voltage	33 VAC/47 VDC	
Peak Pulse	3000 A	
Data Protection		
Service Voltage	6.8 VDC	N/A
Clamping Voltage	2.8 VDC	N/A
Peak Pulse Current	2000 A	N/A
	3.86" x 2.07" x 1.4"	
	14° F -140° F	
Housing	High impact gray plastic	
Connections	Video: BNC Female In/Out, 75 Ohms Data: Terminal Strip (14-22 AWG) Power: Terminal Strip (14-22 AWG)	Video: BNC Female In/Out, 75 Ohms Power: Terminal Strip (14-22 AWG)
Weight	2 oz	

Systems Components and Accessories

POWER SUPPLIES

POWER SUPPLIES

Compared to individual plug-in transformers, a multi-camera power supply reduces the overall cost of the installation and does not tie up multiple power outlets. Centralized power distribution also facilitates easy camera synchronization. There are a wide range of models to meet diverse applications.

110V Power Supplies	
Part #	Description
HPT12DC1000	Single Output DC Plug-In Transformer, 12VDC @ 1000mA, Built in thermal protection and UL recognized, Class 2. Output is a 2.1 mm coax plug which is center positive.
HPT12DC500	Single Output DC Plug-In Transformer, 12VDC @ 500mA, Built in thermal protection and UL recognized, Class 2. Output is a 2.1 mm coax plug which is center positive.
HPT2420	Single Output AC Plug-In Transformer, 24VAC @ 20VA, Built in thermal protection and UL recognized, Class 2.
HPT2440	Single Output AC Plug-In Transformer, 24VAC @ 40VA, Built in thermal protection and UL recognized, Class 2.
HPTV2401WPS	Single Output Power Supply with Surge Suppression for Video and Power. 8A @ 24VAC; NEMA 4 Enclosure
HPTV2401WPZ	Single Output Power Supply with Surge Suppression for Video, Data and Power. 8A @ 24VAC; NEMA 4 Enclosure HPTV2404UL 4 Output Power Supply, 24VAC @ 2.5A each, 4A total, Built in thermal protection, Individually Fused each with LED Indicators. UL Listed
HPTV2408UL 8	Output Power Supply, 24VAC @ 2.5A each, 4A total, Built in thermal protection, Individually Fused each with LED Indicators. UL Listed
HPTV2416UL 16	Output Power Supply, 24VAC @ 2.5A each, 8A total, Built in thermal protection, Individually Fused each with LED Indicators. UL Listed

220V Power Supplies	
Part #	Description
HPTV2402D	Power supply, 240V/24V AC 2A, for Internal use TBD
HPTV2402DWP	Power supply, 230/24V AC, 3A(75VA) Total, 1x1A,1x2A outputs for External Microsphere and heater, mains indicator, power on/off, fuse block, data, BNC in/out, lightening protection, push outs 20, 25, 32, 40mm
HPTV2408-1D	Power supply, 230V/24V AC 8 individually fused 1A outputs, for Internal use
PSU-PER12VDC	Power supply, 12VDC, 500mA - EU & UK Plug

IP Cameras

Box Cameras

Dome Cameras

PTZ Cameras

IR Cameras

Lenses

Special Purpose Cameras

Recording Solutions

Management Software & Systems

System Components

For Additional information, please contact:

Honeywell Security Middle East & North Africa

Post Office Box 18530

LOB Building 08, Office 199

Jebel Ali, Dubai

United Arab Emirates

Tel.: + 971 4 881 5506 / 8073200

Fax.: + 971 4 881 6220

E-mail: SecuritymiddleEast@honeywell.com

www.security.honeywell.com/me

April 2011
© Honeywell Security Middle East
2011

Honeywell